

SECTION 2 / DOMESTIC STEEL SECURITY DOORS

PRODUCT	PAGE
Steel security doors	23-33
Steel security door custom options	34
Vineyard, Paradise, Impressions & Longevity door inserts.....	35
Steel security door list	36-37
Steel patio door & enclosure	38-40
Steel patio door & enclosure options	41
Steel patio door & enclosure list	42-43
Steel window guards	44-45
Steel window guard accessories.....	46
Steel security door mounting variations	47
LIT596 worksheet	48-51
Steel security door short worksheet	52

DOMESTIC STEEL SECURITY DOORS

This section includes photographs and specifications of Precision's line of steel security products. These products are manufactured at our Redlands, CA facility. All items are welded, assembled and finished using high quality raw materials and state of the art equipment. For a complete catalog of Precision products, or if you have any question regarding any Precision products or specifications, please contact your Precision representative or call Precision customer service.

Refer to the "Terms and Conditions" page for warranty information.

The pictures shown may illustrate optional finishes. Standard finishes & sizes for each item are shown on the products corresponding page.

Precision steel security doors come standard as surface mount. Refer to page 47 for mounting variations.

The standard sizes indicated in this section represent "industry standard" door openings.

Refer to the order forms on pages 48-51 or page 52 (compressed version).

Steel security door dimensions:

A. The net overall size, which includes a 1-1/4" sq. 3-piece mounting frame, is as follows:

Door Opening	Net Overall Size
2'6" x 6'8" (30" x 80")	2'9" x 6'9-3/4" (33" x 81-3/4")
2'8" x 6'8" (32" x 80")	2'11" x 6'9-3/4" (35" x 81-3/4")
3'0" x 6'8" (36" x 80")	3'3" x 6'9-3/4" (39" x 81-3/4")

B. When ordering surface mounted, custom size steel security doors: add 3" to the opening width & 1-3/4" to the opening height

C. Standard perforated metal is 24 gauge and is attached to the steel tube frame with stainless steel rivets.

Steel Master - 3812, Italian Leaf - 3824, English Ivy - 3829, Sonoma - 3830 dimensions:

A. The Net Overall Size, which includes a 1-1/2" sq. 1-piece, 3-sided mounting frame, is as follows:

Door Opening	Net Overall Size
2'6" x 6'8" (30" x 80")	2'9-1/2" x 6'10" (33-1/2" x 82")
2'8" x 6'8" (32" x 80")	2'11-1/2" x 6'10" (35-1/2" x 82")
3'0" x 6'8" (36" x 80")	3'3-1/2" x 6'10" (39-1/2" x 82")

B. When ordering surface mounted, custom size Steel Masters: add 3 1/2" to the opening width & 2" to the opening height

C. Standard perforated metal is 24 gauge and is attached to the steel tube frame with stainless steel rivets.

Refer to page 34 for options.

Product availability limited to stock on hand.

Custom doors require a (4) four week lead time on average.

A signed confirmation must be received by Precision before any custom items are scheduled for production. Precision is not responsible for any errors and/or omissions in customer verified information.

On products with perforated metal that is welded in place on special request, the perforated metal may experience deformation and the item may have areas of insufficient finish.

To prevent oxidation (rust), touch up any scratches, chips, etc. with a quality rust inhibiting paint as soon as possible. In order to maintain a rust free finish, regularly inspect and re-paint as needed. In exposed, damp or coastal areas annual painting is recommended.

NEW STEEL MESH OPTIONS

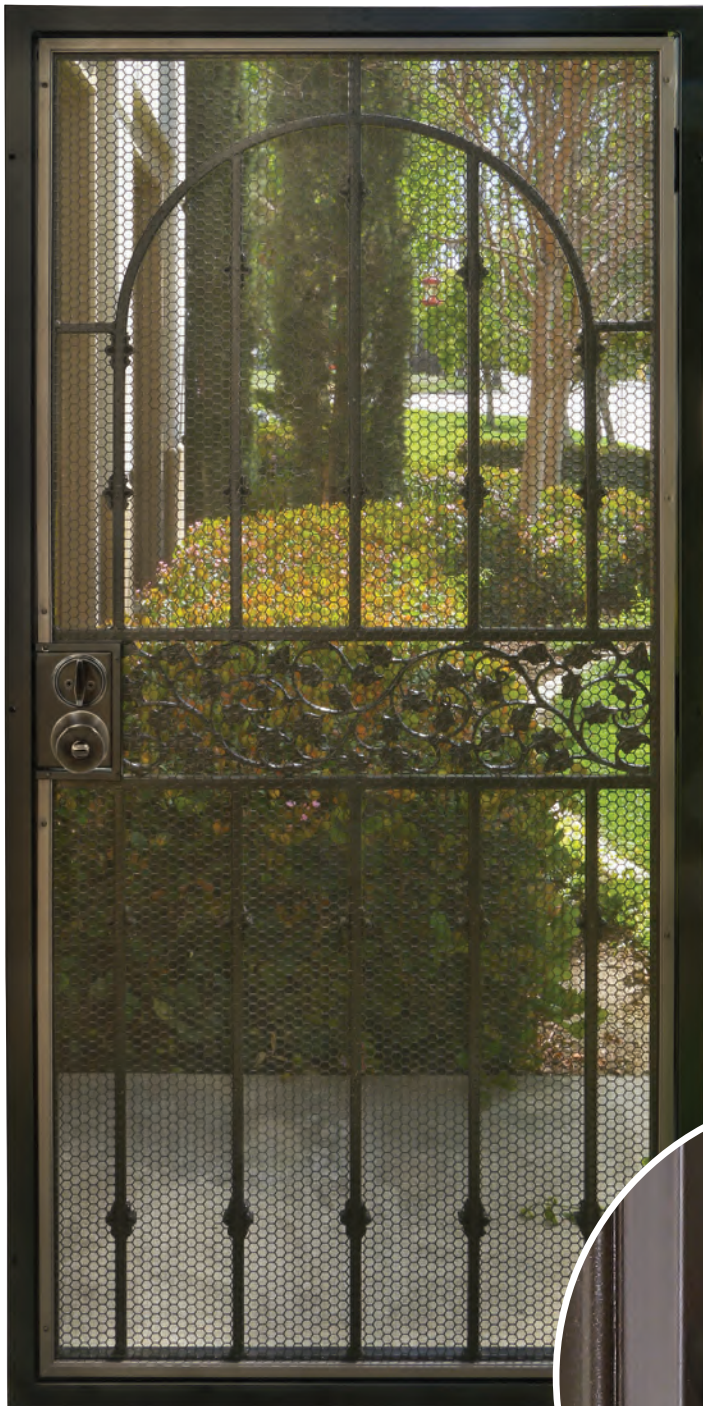

- Offers increased airflow
- Improves visibility
- Removable screen mesh for easy replacement



Actual size

OP-HEXPERFSCREEN22

22 gauge hex perf option with screen
Up to 48" x 84"
79% Open area

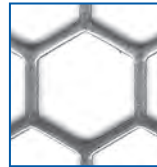

Actual size

OP-HEXPERFSCREEN16 (Shown)

16 gauge hex perf option with screen
Up to 46" x 96"
79% Open area



Actual size

OP-CLOVLEAFPERFSCREEN-22

22 gauge cloverleaf perf option with screen
Up to 48" x 84"
Contrasting color mesh available
50% Open area



Actual size

OP-GRECIANPERFSCREEN-22

22 gauge grecian perf option with screen
Up to 48" x 84"
Contrasting color mesh available
35% Open area



Each door includes a screen panel with 18-16 charcoal screen mesh.

ASK ABOUT CUSTOM WATER JET CUT PATTERNS

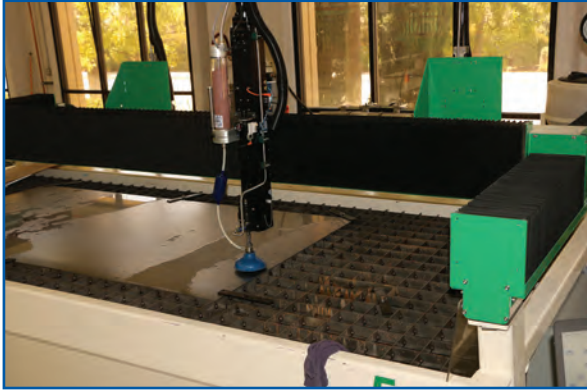

Precision can help design* and manufacture custom panels for security doors, fencing & gates.

DESIGN INSPIRATION

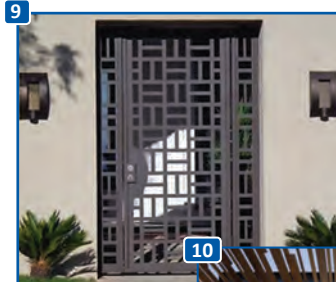
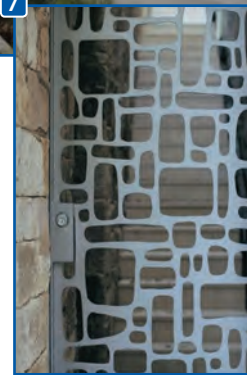
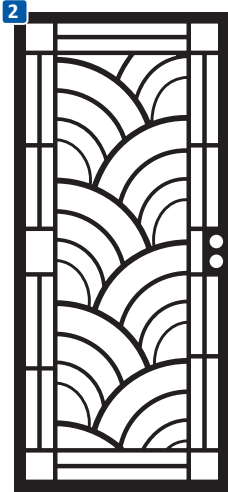
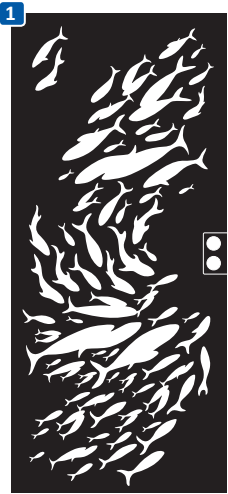

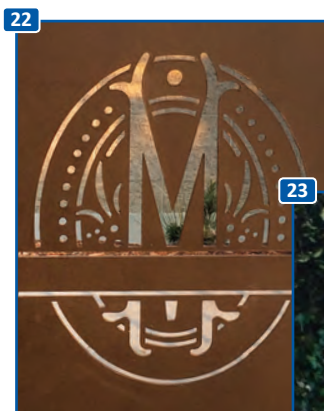
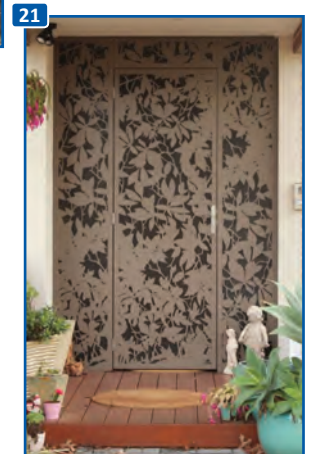
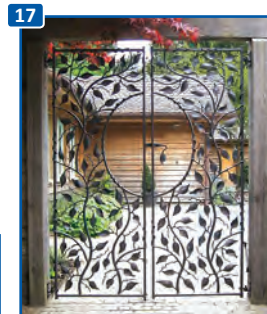
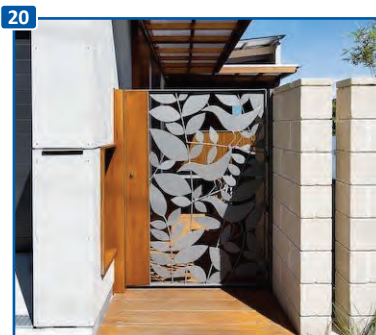
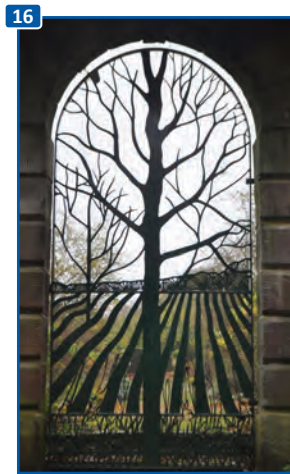
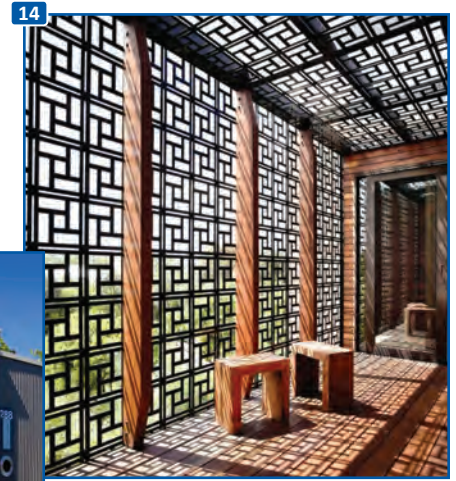
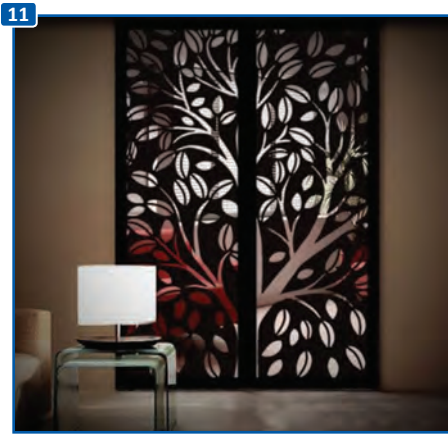

23

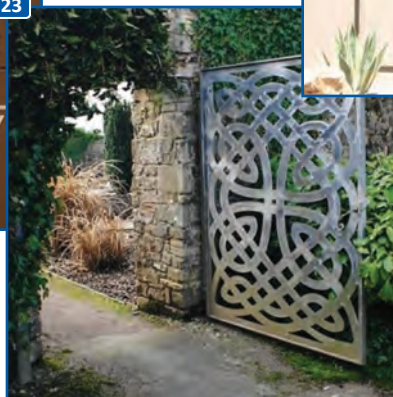

25



26



NEW WATER JET — DOORS —

- Door series are built to order
- Water jet unique designs are cut from 1/8 in. steel
- Standard and custom sizes available
- Doors available in adobe, almond, black, bronze or white
- Contrasting color mesh (as shown) is an upgrade for an additional charge

ABERDEEN



6830 - Single
7830 - Double

ARIZONA



6875 - Single
7875 - Double

BEACON



6800 - Single
7800 - Double

CALYPSO



6833 - Single
7833 - Double

DYNASTY



6845 - Single
7845 - Double

ECLIPSE



6812 - Single
7812 - Double

FIORI



6840 - Single
7840 - Double

GEOTIC



6876 - Single
7876 - Double

LAVENDER



6809 - Single
7809 - Double

MONACO



6807 - Single
7807 - Double

NOUVEAU



6835 - Single
7835 - Double

PORTICO



6802 - Single
7802 - Double

SHERWOOD



6803 - Single
7803 - Double

STARFIRE



6801 - Single
7801 - Double

STEPLOCK



6810 - Single
7810 - Double

SURREY

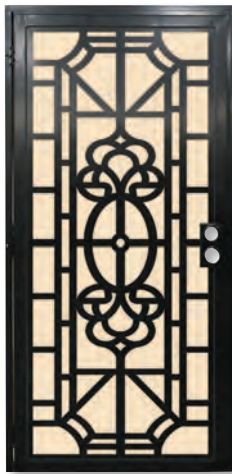

6839 - Single
7839 - Double

VICTORIAN



6806 - Single
7806 - Double

TEST SPECIFICATIONS (Steel Security Doors)

Classification

For the purposes of this standard, door assemblies and components are classified by their relative resistance to forced entry. Four classes of door assemblies and components are established, from class I, with the lowest level of resistance, to class IV, with the highest level of resistance (**Most Precision doors test as a 2 or 3**).

Class I “Light”. For screen door assemblies and components which provide a minimum of physical security. Typically for use in areas where forced entry is unlikely.

2.1.2 Class II “Medium”. For screen door assemblies and components which provide a moderate level of physical security. Typically for use in areas with some access and will allow some deterrent against forced entry.

2.1.3 Class III “Heavy”. For screen door assemblies and components which provide a medium level of physical security. Typically for use in areas with easy access and will act as a deterrent against forced entry.

2.1.4 Class IV “High Security”. For screen door assemblies and components which provide relatively high level of physical security. For use in areas that require a high access denial barrier.

Testing Requirements

TEST DESC.	TEST	METHO D	ACCEPT CRITERIA	MEASURED PARAMETER	TEST RESULT VALUES			
					CLASS I LIGHT	CLASS II MEDIUM	CLASS III HEAVY	CLASS IV HI SECURITY
BOLT PROJECTION STRIKE HOLE	4.2	5.6	6.2.8	PROJECTION SIZE	14.3 mm (9/16 in) *	14.3 mm (9/16 in) *	17.5 mm (11/16 in) *	17.5 mm (11/16 in) *
BOLT PRESSURE	4.3	5.7	6.2.10	RESISTANCE	670 N (150 lbf)	670 N (150 lbf)	670 N (150 lbf)	670 N (150 lbf)
JAMB/WALL STIFFNESS	4.4	5.8	6.2.11	FORCE TO SPREAD	6K N (1,350 lbf)	8K N (1.8K lbf)	16K N (3.6K lbf)	22K N (4.95K lbf)
				INCREASE IN LOCK-FRONT TO STRIKE SPACE	9.5 mm (3/8 in)	9.5 mm (3/8 in)	13 mm (1/2 in)	13 mm (1/2 in)
KNOB IMPACT**	4.5	5.9	6.2.12	RESISTANCE -75 LBF-FT (100 J) IMPACT	ONE BLOW	TWO BLOWS	FIVE BLOWS	TEN BLOWS
CYLINDER CORE TENSION	4.6	5.10	6.2.13	RESISTANCE	1.3K N (290 lbf)	4.8K N (1.08K lbf)	11K N (2.47K lbf)	11K N (2.47K lbf)
CYLINDER BODY TENSION*	4.7	5.11	6.2.14	RESISTANCE	---	---	---	16K N (3.6K lbf)
KNOB TORQUE***	4.8	5.12	6.2.15	RESISTANCE	25 Nm (18.5 lbf-ft)	50 Nm (37 lbf-ft)	110 Nm (81 lbf-ft)	160 Nm (118 lbf-ft)
CYLINDER TORQUE****	4.9	5.13	6.2.16	RESISTANCE	---	---	100 Nm (81 lbf-ft)	160 Nm (118 lbf-ft)
CYLINDER IMPACT*****	4.10	5.14	6.2.16	RESISTANCE -75 LBF-FT (100 J) IMPACT	---	---	FIVE BLOWS	TEN BLOWS
				IMPACT RESISTANCE AT CENTER AND PANEL	2 BLOWS of 80 J (59 ft lbf)	CLASS I REQUIREMENTS PLUS 2 BLOWS OF 120 J (89 ft lbf)	CLASS II REQUIREMENTS PLUS 2 BLOWS OF 160 J (118 ft lbf)	CLASS III REQUIREMENTS PLUS 2 BLOWS OF 200 J (148 ft lbf)
DOOR IMPACT	4.11	5.15	6.2.17	IMPACT RESISTANCE OF GLAZING-75 LBF-FT (100 J) IMPACT	ONE BLOW	TWO BLOWS	FIVE BLOWS	TEN BLOWS
				RESISTANCE	225 N (50 lbf)	225 N (50 lbf)	900 N (200 lbf)	900 N (200 lbf)
HINGE PIN REMOVAL****	4.12	5.16	6.2.19	RESISTANCE	225 N (50 lbf)	225 N (50 lbf)	900 N (200 lbf)	900 N (200 lbf)
HINGE IMPACT	4.13	5.17	6.2.21	IMPACT RESISTANCE AT HINGE	2 BLOWS of 80 J (59 ft lbf)	CLASS I REQUIREMENTS PLUS 2 BLOWS OF 120 J (89 ft lbf)	CLASS II REQUIREMENTS PLUS 2 BLOWS OF 160 J (118 ft lbf)	CLASS III REQUIREMENTS PLUS 2 BLOWS OF 200 J (148 ft lbf)
BOLT IMPACT	4.14	5.18	6.2.22	IMPACT RESISTANCE AT BOLT	2 BLOWS of 80 J (59 ft lbf)	CLASS I REQUIREMENTS PLUS 2 BLOWS OF 120 J (89 ft lbf)	CLASS II REQUIREMENTS PLUS 2 BLOWS OF 160 J (118 ft lbf)	CLASS III REQUIREMENTS PLUS 2 BLOWS OF 200 J (148 ft lbf)
FORCED ENTRY RESISTANCE	4.15	5.19	6.2.23	PRYING RESISTANCE	LOAD A 30LBF (13.6KG) LOAD B 75LBF (34KG) LOAD C 30LBF (13.6KG)	LOAD A 75LBF (34.6KG) LOAD B 150LBF (68KG) LOAD C 75LBF (34.6KG)	LOAD A 150LBF (68KG) LOAD B 300LBF (136KG) LOAD C 150LBF (68KG)	LOAD A 30LBF (13.6KG) LOAD B 75LBF (34KG) LOAD C 30LBF (13.6KG)

Forced Entry Resistance Loads

CLASS	LOAD A	LOAD B	LOAD C
Grade 1	30 lbf (13.6kg)	75 lbf (34kg)	30 lbf (13.6kg)
Grade 2	75 lbf (34.6kg)	150 lbf (68kg)	75 lbf (34kg)
Grade 3	150 lbf (68kg)	300 lbf (136 kg)	150 lbf (68kg)
Grade 4	225 lbf (102kg)	450 lbf (204 kg)	225 lbf (102kg)

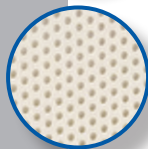

Features

- Standard sizes:
2'6" x 6'8" (33" x 81-3/4" Net overall frame)
2'8" x 6'8" (35" x 81-3/4" Net overall frame)
3'0" x 6'8" (39" x 81-3/4" Net overall frame)
- Custom sizes available
- 1-1/4" sq. x 18 Ga. 3-piece steel mounting frame
- 1" sq. x 18 Ga. steel door frame
- 1/2" sq. x 18 Ga. steel pickets
- "Hummingbird" insert is water jet cut from 1/8" steel and is welded in place. **Must specify handing.**
- For optional insert designs - refer to page 35
- Double hole lock-box w/ 2-1/8" bore & 2-3/8" backset
- Continuous 1/8" x 3/4" lock side "tamper guard"
- Tamper proof hinges
- 24 Ga. perforated steel mesh for extra security
- Contrasting color mesh (as shown) is an upgrade for an additional charge
- Precision SAFEGUARD packaging - complete with one-way mounting screws

Stocked Finishes

- Almond or white with matching powder coated perforated steel mesh

LONGEVITY (Series 3834)

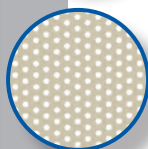

Features

- This door series is built to order
- Standard size:
3'0" x 6'8" (39" x 81-3/4" Net overall frame)
- Custom sizes available
- 1-1/4" sq. x 18 Ga. pre-hung steel mounting frame
- 1" x 2" x 18 Ga. steel door frame
- 5/8" sq. x 18 Ga. vertical pickets
- Removable "Longevity" insert, water jet cut from 1/8" steel
- Signature design at top and bottom
- For optional insert designs - refer to page 35
- Double hole lock-box w/ 2-1/8" bore & 2-3/8" backset
- Continuous 1/8" x 3/4" lock side "tamper guard"
- Tamper proof hinges
- 24 Ga. perforated steel mesh for extra security
- Non-handed
- Contrasting color mesh (as shown) is an upgrade for an additional charge
- Precision SAFEGUARD packaging - complete with one-way mounting screws

Stocked Finishes

- Built to order

Features

- This door series is built to order
- Standard size:
3'0" x 6'8" (39" x 81-3/4" Net overall frame)
- Custom sizes available
- 1-1/4" sq. x 18 Ga. 3-piece mounting frame
- 1" sq. x 18 Ga. steel door frame
- "Vineyard" design, water jet cut from 1/8" steel
- Removable "Welcome" insert, water jet cut from 1/8" steel
- For optional insert designs - refer to page 35
- Double hole lock-box w/ 2-1/8" bore & 2-3/8" backset
- Continuous 1/8" x 3/4" lock side "tamper guard"
- Tamper proof hinges
- 24 Ga. perforated steel mesh for extra security
- Non-handed
- Contrasting color mesh (as shown) is an upgrade for an additional charge
- **Custom design services available**
- Precision SAFEGUARD packaging - complete with one-way mounting screws

Stocked Finishes

- Built to order

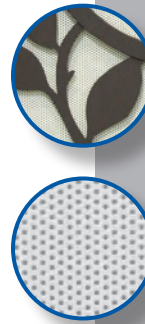

Water Jet Cut Panel



(Series 3826) VINEYARD FULL

Features

- This door series is built to order
- Standard size:
3'0" x 6'8" (39" x 81-3/4" Net overall frame)
- Custom sizes available
- 1-1/4" sq. x 18 Ga. 3-piece mounting frame
- 1" sq. x 18 Ga. steel door frame
- "Vineyard" design, water jet cut from 1/8" steel
- Double hole lock-box w/ 2-1/8" bore & 2-3/8" backset
- Continuous 1/8" x 3/4" lock side "tamper guard"
- Tamper proof hinges
- 24 Ga. perforated steel mesh for extra security
- Non-handed
- Contrasting color mesh (as shown) is an upgrade for an additional charge
- **Custom design services available**
- Precision SAFEGUARD packaging - complete with one-way mounting screws

Stocked Finishes

- Built to order



Water Jet Cut Panel



Water Jet Cut Panel

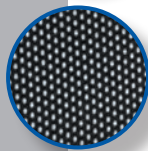

Features

- This door series is built to order
- Standard sizes:
2'6" x 6'8" (33" x 81-3/4" Net overall frame)
2'8" x 6'8" (35" x 81-3/4" Net overall frame)
3'0" x 6'8" (39" x 81-3/4" Net overall frame)
- Custom sizes available
- 1-1/4" sq. x 18 Ga. 3-piece steel mounting frame
- 1" sq. x 18 Ga. steel door frame
- 1/2" sq. x 18 Ga. steel pickets
- Removable "Welcome" insert, water jet cut from 1/8" steel
- For optional insert designs - refer to page 35
- Double hole lock-box w/ 2-1/8" bore & 2-3/8" backset
- Continuous 1/8" x 3/4" lock side "tamper guard"
- Tamper proof hinges
- 24 Ga. perforated steel mesh for extra security
- Non-handed
- Contrasting color mesh (as shown) is an upgrade for an additional charge
- Precision SAFEGUARD packaging - complete with one-way mounting screws

Stocked Finishes

- Built to order

SOUTHWEST (Series 3837)

Water Jet Cut Panel

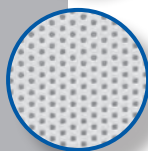

Features

- This door series is built to order
- Standard size:
3'0" x 6'8" (39" x 81-3/4" Net overall frame)
- Custom sizes available
- 1-1/4" sq. x 18 Ga. 3-piece mounting frame
- 1" sq. x 18 Ga. steel door frame
- "Southwest" design, water jet cut from 1/8" steel
- Double hole lock-box w/ 2-1/8" bore & 2-3/8" backset
- Continuous 1/8" x 3/4" lock side "tamper guard"
- Tamper proof hinges
- 24 Ga. perforated steel mesh for extra security
- Non-handed
- Contrasting color mesh (as shown) is an upgrade for an additional charge
- **Custom design services available**
- Precision SAFEGUARD packaging - complete with one-way mounting screws

Stocked Finishes

- Built to order

Features

- This door series is built to order
- Standard size:
3'0" x 6'8" (39" x 81-3/4" Net overall frame)
- Custom sizes available
- 1-1/4" sq. x 18 Ga. 3-piece mounting frame
- 1" sq. x 18 Ga. steel door frame
- "San Marino" design, water jet cut from 1/8" steel
- Double hole lock-box w/ 2-1/8" bore & 2-3/8" backset
- Continuous 1/8" x 3/4" lock side "tamper guard"
- Tamper proof hinges
- 24 Ga. perforated steel mesh for extra security
- Non-handed
- Contrasting color mesh (as shown) is an upgrade for an additional charge
- **Custom design services available**
- Precision SAFEGUARD packaging - complete with one-way mounting screws

Stocked Finishes

- Built to order



Water Jet Cut Panel



Features

- This door series is built to order
- Standard size:
3'0" x 6'8" (39" x 81-3/4" Net overall frame)
- Custom sizes available
- 1-1/4" sq. x 18 Ga. 3-piece mounting frame
- 1" sq. x 18 Ga. steel door frame
- "Deco" design, water jet cut from 1/8" steel
- Double hole lock-box w/ 2-1/8" bore & 2-3/8" backset
- Continuous 1/8" x 3/4" lock side "tamper guard"
- Tamper proof hinges
- 24 Ga. perforated steel mesh for extra security
- Non-handed
- Contrasting color mesh (as shown) is an upgrade for an additional charge
- **Custom design services available**
- Precision SAFEGUARD packaging - complete with one-way mounting screws

Stocked Finishes

- Built to order



Water Jet Cut Panel



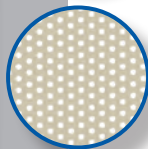

Features

- This door series is built to order
- Custom sizes available
- 1-1/4" sq. x 18 Ga. 3-piece mounting frame
- 1" sq. x 18 Ga. steel door frame
- 1/2" sq. x 18 Ga. vertical steel pickets
- 3/4" sq. x 18 Ga. horizontal steel pickets
- Double hole lock-box w/ 2-1/8" bore & 2-3/8" backset
- Continuous 1/8" x 3/4" lock side "tamper guard"
- Tamper proof hinges
- 24 Ga. perforated steel mesh for extra security
- Non-handed
- Contrasting color mesh (as shown) is an upgrade for an additional charge
- Precision SAFEGUARD packaging - complete with one-way mounting screws

Stocked Finishes

- Built to order

ITALIAN LEAF (Series 3824)

Heavy Duty

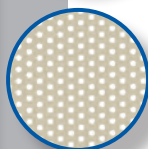

Features

- **1-1/2" sq. x 16 Ga. 1-piece, 3-sided steel mounting frame**
- 1" sq. x 18 Ga. steel door frame
- 1" sq. x 18 Ga. horizontal pickets
- 5/8" sq. x 18 Ga. vertical pickets
- 1/4" x 12" steel scrolls w/leaves
- Decorative collars on pickets
- Double hole lock-box, w/ 2-1/8" bore & 2-3/8" backset
- **Lock ring guard**
- Continuous 1/8" x 1" steel top & lock side "tamper guard"
- Tamper proof hinges
- 24 Ga. perforated steel mesh for extra security
- **Specify left or right side hinges (from outside looking in)**
- Contrasting color mesh (as shown) is an upgrade for an additional charge
- Precision SAFEGUARD packaging - complete with one-way mounting screws

Stocked Finishes

- Built to order

Features

- 1-1/2" sq. x 16 Ga. 1-piece, 3-sided steel mounting frame
- 1" sq. x 18 Ga. steel door frame
- 3/4" sq. x 18 Ga. horizontal steel pickets
- 5/8" sq. x 18 Ga. vertical & arched pickets
- Aluminum ivy casting at center
- Decorative collars on pickets
- Double hole lock-box w/ 2-1/8" bore & 2-3/8" backset
- **Lock ring guard**
- Continuous 1/8" x 1" steel top & lock side "tamper guard"
- Tamper proof hinges
- 24 Ga. perforated steel mesh for extra security
- **Specify left or right side hinges (from outside looking in)**
- Contrasting color mesh is an upgrade for an additional charge
- **High air flow hex perf mesh (as shown) is an upgrade for an additional charge**
- Precision SAFEGUARD packaging - complete with one-way mounting screws

Stocked Finishes

- Built to order

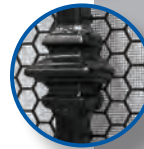

Heavy Duty



Features

- 1-1/2" sq. x 16 Ga. 1-piece, 3-sided steel mounting frame
- 1" sq. x 18 Ga. steel door frame
- 3/4" sq. x 18 Ga. horizontal steel pickets
- 5/8" sq. x 18 Ga. vertical & arched pickets
- Aluminum grape vine casting at center
- Aluminum grape vine casting at top
- Double hole lock-box w/ 2-1/8" bore & 2-3/8" backset
- **Lock ring guard**
- Continuous 1/8" x 1" steel top & lock side "tamper guard"
- Tamper proof hinges
- 24 Ga. perforated steel mesh for extra security
- **Specify left or right side hinges (from outside looking in)**
- Contrasting color mesh (as shown) is an upgrade for an additional charge
- Precision SAFEGUARD packaging - complete with one-way mounting screws

Stocked Finishes

- Built to order

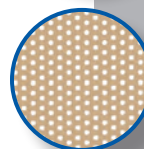

Heavy Duty



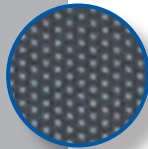

Features

- Standard sizes:
2'6" x 6'8" (33" x 81-3/4" Net overall frame)
2'8" x 6'8" (35" x 81-3/4" Net overall frame)
3'0" x 6'8" (39" x 81-3/4" Net overall frame)
- Custom sizes available
- 1-1/4" sq. x 18 Ga. 3-piece steel mounting frame
- 1" sq. x 18 Ga. steel door frame
- Double hole lock-box w/ 2-1/8" bore & 2-3/8" backset
- Continuous 1/8" x 3/4" lock side "tamper guard"
- Tamper proof hinges
- 24 Ga. perforated steel mesh for extra security
- 3/4" Thick pine wood, colonial pattern with light oak stain insert
- Non-handed
- Contrasting color mesh is an upgrade for an additional charge
- Precision SAFEGUARD packaging - complete with one-way mounting screws

Stocked Finishes

- Frame only: Almond, black, bronze or white powder coated
Wood insert is only available in oak stain

DAKOTA (Series 3814)

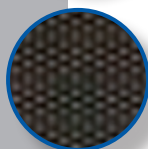

Features

- Standard sizes:
2'6" x 6'8" (33" x 81-3/4" Net overall frame)
2'8" x 6'8" (35" x 81-3/4" Net overall frame)
3'0" x 6'8" (39" x 81-3/4" Net overall frame)
- Custom sizes available
- 1-1/4" sq. x 18 Ga. 3-piece steel mounting frame
- 1" x 2" x 16 Ga. steel door frame
- 1" sq. x 18 Ga. steel horizontal tubes at lock-box, top, & bottom
- 1/2" sq. x 18 Ga. vertical steel pickets
- 1/2" sq. x 18 Ga. horizontal steel pickets at top, center & bottom
- 11 Ga. Dakota designs at top, center, & bottom
- Double hole lock-box w/ 2-1/8" bore & 2-3/8" backset
- Continuous 1/8" x 3/4" lock side "tamper guard"
- Tamper proof hinges
- 24 Ga. perforated steel mesh for extra security
- Non-handed
- Contrasting color mesh (as shown) is an upgrade for an additional charge
- Precision SAFEGUARD packaging - complete with one-way mounting screws

Stocked Finishes

- Adobe or almond with matching powder coated perforated steel mesh

Features

- Standard sizes:
2'6" x 6'8" (33" x 81-3/4" Net overall frame)
2'8" x 6'8" (35" x 81-3/4" Net overall frame)
3'0" x 6'8" (39" x 81-3/4" Net overall frame)
- Custom sizes available
- 1-1/4" sq. x 18 Ga. 3-piece steel mounting frame
- 1" sq. x 18 Ga. steel door frame
- 1" sq. x 18 Ga. steel horizontal tubes at lock-box
- 1/2" sq. x 18 Ga. vertical steel pickets (2 twisted - 3 straight)
- Ten signature aluminum castings
- Double hole lock-box w/ 2-1/8" bore & 2-3/8" backset
- Continuous 1/8" x 3/4" lock side "tamper guard"
- Tamper proof hinges
- 24 Ga. perforated steel mesh for extra security
- Non-handed
- Contrasting color mesh (as shown) is an upgrade for an additional charge
- Precision SAFEGUARD packaging - complete with one-way mounting screws

Stocked Finishes

- Black or white with matching powder coated perforated steel mesh

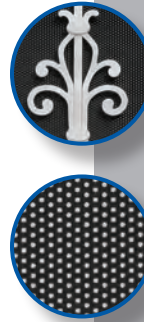

Features

- Standard sizes:
2'6" x 6'8" (33" x 81-3/4" Net overall frame)
2'8" x 6'8" (35" x 81-3/4" Net overall frame)
3'0" x 6'8" (39" x 81-3/4" Net overall frame)
- Custom sizes available
- 1-1/4" sq. x 18 Ga. 3-piece mounting frame
- 1" sq. x 18 Ga. steel door frame
- 1/2" sq. x 18 Ga. vertical steel pickets
- 1/2" sq. x 18 Ga. horizontal steel pickets
- Two signature aluminum castings
- Double hole lock-box w/ 2-1/8" bore & 2-3/8" backset
- Continuous 1/8" x 3/4" lock side "tamper guard"
- Tamper proof hinges
- 24 Ga. perforated steel mesh for extra security
- Non-handed
- Contrasting color mesh (as shown) is an upgrade for an additional charge
- Precision SAFEGUARD packaging - complete with one-way mounting screws

Stocked Finishes

- Adobe, almond, black, bronze or white with matching powder coated perforated steel mesh

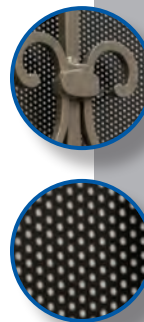

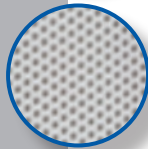

Features

- Standard sizes:
 - 2'6" x 6'8" (33" x 81-3/4" Net overall frame)
 - 2'8" x 6'8" (35" x 81-3/4" Net overall frame)
 - 3'0" x 6'8" (39" x 81-3/4" Net overall frame)
- Custom sizes available
- 1-1/4" sq. x 18 Ga. 3-piece steel mounting frame
- 1" sq. x 18 Ga. steel door frame
- 1/2" sq. x 18 Ga. vertical steel pickets
- 1/2" sq. x 18 Ga. horizontal steel pickets
- 1/8" Thick x 1/2" wide steel scroll design
- Double hole lock-box w/ 2-1/8" bore & 2-3/8" backset
- Continuous 1/8" x 3/4" lock side "tamper guard"
- Tamper proof hinges
- 24 Ga. perforated steel mesh for extra security
- Non-handed
- Contrasting color mesh (as shown) is an upgrade for an additional charge
- Precision SAFEGUARD packaging - complete with one-way mounting screws

Stocked Finishes

- Black, bronze or white with matching powder coated perforated steel mesh

MADRID (Series 3806)

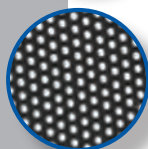

Features

- Standard sizes:
 - 2'6" x 6'8" (33" x 81-3/4" Net overall frame)
 - 2'8" x 6'8" (35" x 81-3/4" Net overall frame)
 - 3'0" x 6'8" (39" x 81-3/4" Net overall frame)
- Custom sizes available
- 1-1/4" sq. x 18 Ga. 3-piece steel mounting frame
- 1" sq. x 18 Ga. steel door frame
- 1" sq. x 18 Ga. steel horizontal tubes at lock-box
- 1/2" sq. x 18 Ga. vertical steel pickets (3 twisted - 2 straight)
- 1/2" sq. x 18 Ga. horizontal steel pickets
- 1/8" thick x 1/2" wide steel scroll designs
- Double hole lock-box w/ 2-1/8" bore & 2-3/8" backset
- Continuous 1/8" x 3/4" lock side "tamper guard"
- Tamper proof hinges
- 24 Ga. perforated steel mesh for extra security
- Non-handed
- Contrasting color mesh is an upgrade for an additional charge
- Precision SAFEGUARD packaging - complete with one-way mounting screws

Stocked Finishes

- Black or white with matching powder coated perforated steel mesh

Features

- Standard sizes:
2'6" x 6'8" (33-1/2" x 82" Net overall frame)
2'8" x 6'8" (35-1/2" x 82" Net overall frame)
3'0" x 6'8" (39-1/2" x 82" Net overall frame)
- Custom sizes available
- **1-1/2" sq. x 16 Ga. one piece - 3 sided steel mounting frame**
- 1" sq. x 18 Ga. steel door frame
- 5/8" sq. x 18 Ga. vertical steel pickets
- 3/8" sq. x 18 Ga. horizontal steel pickets
- 1/8" thick x 1/2" wide steel scroll designs
- Double hole lock-box w/ 2-1/8" bore & 2-3/8" backset
- **Lock ring guard**
- Continuous 1/8" x 1" steel top & lock side "tamper guard"
- Tamper proof hinges
- 24 Ga. perforated steel mesh for extra security

Specify left or right side hinges (from outside looking in)

- Contrasting color mesh is an upgrade for an additional charge
- Precision SAFEGUARD packaging - complete with one-way mounting screws

Stocked Finishes

- Black with matching powder coated perforated steel mesh

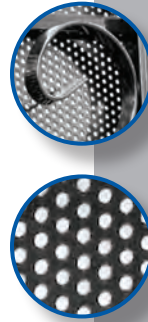

Heavy Duty



Features

- Standard sizes:
2'6" x 6'8" (33" x 81-3/4" Net overall frame)
2'8" x 6'8" (35" x 81-3/4" Net overall frame)
3'0" x 6'8" (39" x 81-3/4" Net overall frame)
- Custom sizes available
- 1-1/4" sq. x 18 Ga. 3-piece steel mounting frame
- 1" x 2" x 16 Ga. steel door frame
- 5/8" sq. x 18 Ga. crescent picket at lock-box
- 1/2" sq. x 18 Ga. radiant pickets
- Double hole lock-box w/ 2-1/8" bore & 2-3/8" backset
- Continuous 1/8" x 3/4" lock side "tamper guard"
- Tamper proof hinges
- 24 Ga. perforated steel mesh for extra security
- Non-handed
- Contrasting color mesh (as shown) is an upgrade for an additional charge
- Precision SAFEGUARD packaging - complete with one-way mounting screws

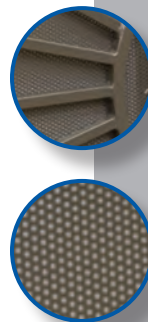

Stocked Finishes

- Adobe, almond, black, bronze or white with matching powder coated perforated steel mesh



Features

- Standard sizes:
 - 2'6" x 6'8" (33" x 81-3/4" Net overall frame)
 - 2'8" x 6'8" (35" x 81-3/4" Net overall frame)
 - 3'0" x 6'8" (39" x 81-3/4" Net overall frame)
- Custom sizes available
- 1-1/4" sq. x 18 Ga. 3-piece steel mounting frame
- 1" sq. x 18 Ga. steel door frame
- 5/8" sq. x 18 Ga. vertical steel pickets
- 1/2" sq. x 18 Ga. horizontal steel pickets
- Double hole lock-box w/ 2-1/8" bore & 2-3/8" backset
- Continuous 1/8" x 3/4" lock side "tamper guard"
- Tamper proof hinges
- 24 Ga. perforated steel mesh for extra security
- Non-handed
- Contrasting color mesh (as shown) is an upgrade for an additional charge
- Precision SAFEGUARD packaging - complete with one-way mounting screws

Stocked Finishes

- Adobe, almond, black, bronze, or white with matching powder coated perforated steel mesh

CAROLINA (Series 3811)



Features

- Standard sizes:
 - 2'6" x 6'8" (33" x 81-3/4" Net overall frame)
 - 2'8" x 6'8" (35" x 81-3/4" Net overall frame)
 - 3'0" x 6'8" (39" x 81-3/4" Net overall frame)
- Custom sizes available
- 1-1/4" sq. x 18 Ga. 3-piece steel mounting frame
- 1" x 2" x 16 Ga. steel door frame
- 5/8" sq. x 18 Ga. vertical steel pickets
- 1/2" sq. x 18 Ga. horizontal steel pickets
- Double hole lock-box w/ 2-1/8" bore & 2-3/8" backset
- Continuous 1/8" x 3/4" lock side "tamper guard"
- Tamper proof hinges
- 24 Ga. perforated steel mesh for extra security
- Non-handed
- Contrasting color mesh (as shown) is an upgrade for an additional charge
- Precision SAFEGUARD packaging - complete with one-way mounting screws

Stocked Finishes

- White with matching powder coated perforated steel mesh

STEEL SECURITY DOORS

Custom options (add-ons) for domestic steel security doors

Product Line Z9999 for all options on this page

Option	Option Code	Description
Mounting Variations (Refer to Page 47)	OP-SurfaceMt	Surface mount (standard)
	OP-InsetMt	Inset mount
	OP-InstMtTab	Inset mount w/tabs (specify tab size)
	OP-SurfMtTab	Surface mount w/tabs (specify tab size)
	OP-SMStndOffTab	Surface mount w/stand-off tabs (specify tab size)
	OP-SMTubeBack	Surface mount w/tube backing
	OP-IMFullStrap	Inset mount w/full strapping (specify strapping width)
	OP-IMSurfTab	Inset mount w/surface tabs (specify tab size)
Frame Variations	OP-3Piece	Three piece - door w/hinge bar, header bar, & strike bar (standard)
	OP-1Pc3Side1.25	One piece 3-sided 1-1/4" pre-hung frame
	OP-1Pc3Side1.5	One piece 3-sided 1-1/2" pre-hung frame
	OP-1Pc4Side1.25	One piece 4-sided 1-1/4" pre-hung frame
	OP-1Pc4Side1.5	One piece 4-sided 1-1/2" pre-hung frame
Double Door		Set-up (price of two custom doors and add:)
	OP-DDCaneBolts	Double door w/cane-bolts (standard)
	OP-DDFlushBolts	Double door w/flush extension bolts in door stile
Lock-Box	OP-INSTL8560	Single hole lock-box
	OP-RingGuard	Ring guard - welded
	OP-HandlePull	Handle pull
	OP-SpecLBLoc	Special lock-box location
Door Coverings	OP-24GaPerf	24 Ga. perforated steel mesh w/ 3/32" dia holes (standard)
	OP-ContPerf	Contrasting color perforated mesh
	OP-16GaExpnd	16 Ga. 1/2" expanded metal screen
	OP-13GaExpnd	13 Ga. 1/2" expanded metal screen
	OP-24GaSolid	24 Ga. solid sheet metal
	OP-HexPerfScreen-16	16 Ga. hexagon perforated steel mesh w/ screen
	OP-HexPerfScreen-22	22 Ga. hexagon perforated steel mesh w/ screen
	OP-NoPerf	No covering
Mail Slots	OP-MailSlitNoCvr	Cut-out, no cover (12" x 3" I.D.)
	OP-MailSlitWCvr	Cut-out, with cover (12" x 3" I.D.)
Pet Door Cut-Outs	OP-PD-CUTOUT-S	Cut-out for small pet door
	OP-PD-CUTOUT-M	Cut-out for medium pet door
	OP-PD-CUTOUT-L	Cut-out for large pet door
	OP-PD-CUTOUT-X	Cut-out for extra-large pet door
Pet Door Installed	OP-PD-STL-S	Cut-out and install small pet door
	OP-PD-STL-M	Cut-out and install medium pet door
	OP-PD-STL-L	Cut-out and install large pet door
	OP-PD-STL-X	Cut-out and install extra large pet door
Transoms (Up to 24" High)	OP-Trnsm-NoPerf	To doors with no perforated steel mesh
	OP-Trnsm-Perf	To doors with perforated steel mesh
	OP-Trnsm-Perf	To doors with expanded metal mesh
	OP-ArchedTop	Arched doors one piece pre-hung frame only - specify handing, provide template
Hydraulic Closer	OP-HydraulicClr	Hydraulic closer installed with mounting plates welded to frame & door
Primer	OP-Primerpaint	Primer undercoat + paint for extra rust protection

See price list for additional "OP" options

SECURITY DOOR ACCESSORIES



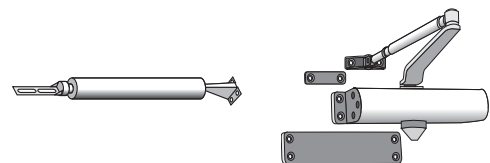









Option	Product Line	Description
2126BZ	F3970	Standard door closer, bronze
2126BK	F3970	Standard door closer, black
2127BK	G8002	Heavy duty closer, black
213007	G8002	Hydraulic door closer w/plates, gray only









REMOVABLE INSERT DESIGNS





For Vineyard, Paradise, Impressions & Longevity doors

Standard colors: Adobe, almond, black, bronze or white

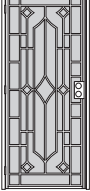

Product Line	Description	Option Code	Product Line	Description	Option Code		
	G8805	Cactus	OP-Cactus		G8805	Humming bird <i>Included standard with Paradise doors</i>	OP-Hummingbird
	G8805	Coyote	OP-Coyote		G8805	Longevity <i>Included standard with Longevity doors</i>	OP-Longevity
	G8805	Deer scene	OP-DeerScene		G8805	Love birds	OP-Lovebirds
	G8805	Dolphins	OP-Dolphin		G8805	Palm tree	OP-PalmTree
	G8805	Gecko	OP-Gecko		G8805	Welcome <i>Included standard with Impressions & Vineyard doors</i>	OP-Welcome
	G8805	Horse	OP-Horse		G8805	Whale tail	OP-Whaletail

DOMESTIC STEEL SECURITY DOORS Standard size security doors

Name/ Series	Product Line	Description
Paradise 3808 Page 23	G3012	 <p>Available in 2'6", 2'8" & 3'0" x 6'8" Custom sizes available 1-1/4" sq. x 18 Ga. 3-piece mounting frame 1" sq. x 18 Ga. steel door frame Welded on "hummingbird" insert 24 Ga. perf. steel mesh for extra security Stocked colors: Almond or white with matching powder coated perforated steel mesh</p>
Longevity 3834 Page 23	G3007	 <p>This door series is built to order 1-1/4" sq. x 18 Ga. pre-hung mounting frame 1" x 2" x 16 Ga. steel door frame Removable "longevity" insert 24 Ga. perf. steel mesh for extra security</p>
Vineyard 3823 Page 24	G3007	 <p>This door series is built to order 1-1/4" sq. x 18 Ga. 3-piece mounting frame 1" sq. x 18 Ga. steel door frame "Vineyard" design, water jet cut from 1/8" steel Removable "welcome" insert</p>
Vineyard Full 3826 Page 24 NEW!	G3012	 <p>This door series is built to order 1-1/4" sq. x 18 Ga. 3-piece mounting frame 1" sq. x 18 Ga. steel door frame "Vineyard full" design, water jet cut from 1/8" steel</p>
Impressions 3822 Page 25	G3007	 <p>This door series is built to order 1-1/4" sq. x 18 Ga. 3-piece mounting frame 1" sq. x 18 Ga. steel door frame Removable "welcome" insert 24 Ga. perf. steel mesh for extra security</p>
Southwest 3837 Page 25 NEW!	G3012	 <p>This door series is built to order 1-1/4" sq. x 18 Ga. 3-piece mounting frame 1" sq. x 18 Ga. steel door frame "Southwest" design, water jet cut from 1/8" steel</p>

Name/ Series	Product Line	Description
San Marino 3840 Page 26 NEW!	G3012	 <p>This door series is built to order 1-1/4" sq. x 18 Ga. 3-piece mounting frame 1" sq. x 18 Ga. steel door frame "San Marino" design, water jet cut from 1/8" steel</p>
Deco 3842 Page 26 NEW!	G3012	 <p>This door series is built to order 1-1/4" sq. x 18 Ga. 3-piece mounting frame 1" sq. x 18 Ga. steel door frame "Deco" design, water jet cut from 1/8" steel</p>
Franciscan 3815 Page 27 NEW!	G3007	 <p>This door series is built to order 1-1/4" sq. x 18 Ga. 3-piece mounting frame 1" sq. x 18 Ga. steel door frame 24 Ga. perf. steel mesh for extra security</p>
Italian Leaf 3824 Page 27 NEW!	G3007	 <p>This door series is built to order 1-1/2" sq. x 16 Ga. one-piece mounting frame 1" sq. x 18 Ga. steel door frame 24 Ga. perf. steel mesh for extra security</p>
English Ivy 3829 Page 28 NEW!	G3007	 <p>This door series is built to order 1-1/2" sq. x 16 Ga. one-piece mounting frame 1" sq. x 18 Ga. steel door frame 24 Ga. perf. steel mesh for extra security</p>
Sonoma 3830 Page 28 NEW!	G3007	 <p>This door series is built to order 1-1/2" sq. x 16 Ga. one-piece mounting frame 1" sq. x 18 Ga. steel door frame 24 Ga. perf. steel mesh for extra security</p>

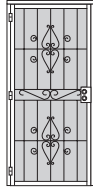
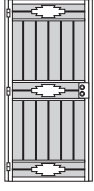
DOMESTIC STEEL SECURITY DOORS Standard size security doors

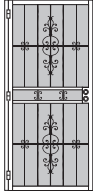
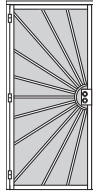
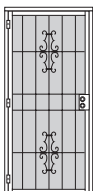
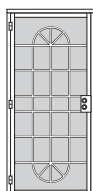
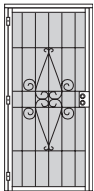
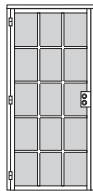
Name/ Series	Product Line	Description	Name/ Series	Product Line	Description
Woodguard 3809 Page 29	G3007	 <p>Available in 2'6", 2'8" & 3'0" x 6'8" Custom sizes available 1-1/4" sq. x 18 Ga. 3-piece mounting frame 1" sq. x 18 Ga. steel door frame 3/4" Thick colonial wood pattern 24 Ga. perf. steel mesh for extra security Stocked colors: Frame only: Almond, black, bronze or white Wood insert is only available in oak stain</p>	Madrid 3806 Page 31	G3012	 <p>Available in 2'6", 2'8" & 3'0" x 6'8" Custom sizes available 1-1/4" sq. x 18 Ga. 3-piece mounting frame 1" sq. x 18 Ga. steel door frame 1/8" Thick x 1/2" wide steel scroll designs 24 Ga. perf. steel mesh for extra security Stocked colors: Black or white with matching powder coated perforated steel mesh</p>
Dakota 3814 Page 29	G3007	 <p>Available in 2'6", 2'8" & 3'0" x 6'8" Custom sizes available 1-1/4" sq. x 18 Ga. 3-piece mounting frame 1" x 2" x 16 Ga. steel door frame 11 Ga. Dakota designs at top, center, & bottom 24 Ga. perf. steel mesh for extra security Stocked colors: Adobe or almond with matching powder coated perforated steel mesh</p>	Steel Master 3812 Page 32	G3007	 <p>Available in 2'6", 2'8" & 3'0" x 6'8" Custom sizes available 1-1/2" sq. x 16 Ga. one piece - 3 sided frame 1" sq. x 16 Ga. steel door frame 1/8" Thick x 1/2" wide steel scroll designs 24 Ga. perf. steel mesh for extra security Stocked colors: Black with matching powder coated perforated steel mesh</p>
Imperial 3831 Page 30	G3009	 <p>Available in 2'6", 2'8" & 3'0" x 6'8" Custom sizes available 1-1/4" sq. x 18 Ga. 3-piece mounting frame 1" sq. x 18 Ga. steel door frame Ten signature aluminum castings 24 Ga. perf. steel mesh for extra security Stocked colors: Black or white with matching powder coated perforated steel mesh</p>	Sunburst 3841 Page 32	G3007	 <p>Available in 2'6", 2'8" & 3'0" x 6'8" Custom sizes available 1-1/4" sq. x 18 Ga. 3-piece mounting frame 1" x 2" x 16 Ga. steel door frame 1/2" sq. x 18 Ga. radiant pickets 24 Ga. perf. steel mesh for extra security Stocked colors: Adobe, almond, black, bronze or white with matching powder coated perforated steel mesh</p>
Granada 3803 Page 30	G3007	 <p>Available in 2'6", 2'8" & 3'0" x 6'8" Custom sizes available 1-1/4" sq. x 18 Ga. 3-piece mounting frame 1" sq. x 18 Ga. steel door frame Two signature aluminum castings 24 Ga. perf. steel mesh for extra security Stocked colors: Adobe, almond, black, bronze or white with matching powder coated perforated steel mesh</p>	Clarion 3821 Page 33	G3007	 <p>Available in 2'6", 2'8" & 3'0" x 6'8" Custom sizes available 1-1/4" sq. x 18 Ga. 3-piece mounting frame 1" sq. x 18 Ga. steel door frame 24 Ga. perf. steel mesh for extra security Stocked colors: Adobe, almond, black, bronze or white with matching powder coated perforated steel mesh</p>
Barcelona 3804 Page 31	G3007	 <p>Available in 2'6", 2'8" & 3'0" x 6'8" Custom sizes available 1-1/4" sq. x 18 Ga. 3-piece mounting frame 1" sq. x 18 Ga. steel door frame 1/8" Thick x 1/2" wide steel scroll design 24 Ga. perf. steel mesh for extra security Stocked colors: Black, bronze or white with matching powder coated perforated steel mesh</p>	Carolina 3811 Page 33	G3007	 <p>Available in 2'6", 2'8" & 3'0" x 6'8" Custom sizes available 1-1/4" sq. x 18 Ga. 3-piece mounting frame 1" x 2" x 18 Ga. steel door frame 24 Ga. perf. steel mesh for extra security Stocked colors: White with matching powder coated perforated steel mesh</p>

DOUBLE DOOR, PATIO DOOR & PORCH ENCLOSURES

CENTURION

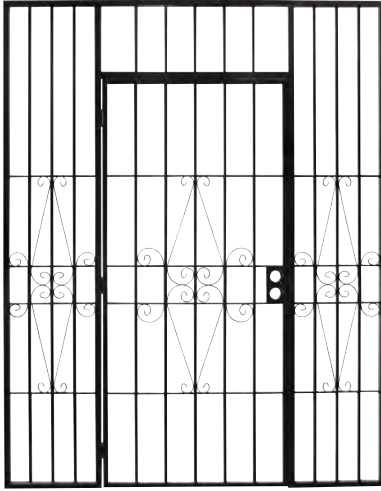

Porch

KNIGHTGUARD

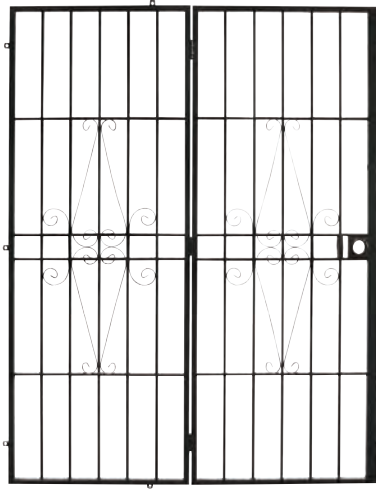

Double

SENTINEL

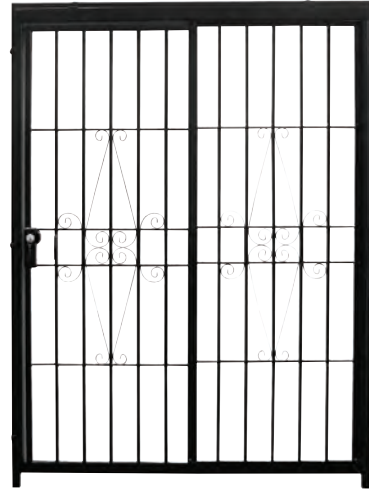

Patio

Most single door patterns can be ordered on the above systems. Refer to each page for limitations.

Example: Franciscan double door





Features

- Custom built to order
- 1-1/4" sq. x 16 Ga. one piece frame
- 1 ea. 3'0" x 6'8" Standard door
- 1" sq. x 16 Ga. steel door frame
- 5/8" sq. x 18 Ga. vertical steel pickets
- 3/8" sq. x 18 Ga. horizontal steel pickets
- 1/8" Thick x 1/2" wide steel scroll designs
- Double hole lock-box w/ 2-1/8" bore & 2-3/8" backset
- Continuous 1/8" x 1" "tamper guard" on lock side & top
- Tamper proof hinges
- Optional 24 Ga. perforated steel mesh for extra security is available as an upgrade for an additional charge

- **Must specify handing**

Stocked Finishes

- Built to order

***Cannot make in Deco, San Marino, or any other water jet cut patterns on this system**

KNIGHTGUARD HINGED PATIO DOOR (Series 3902)

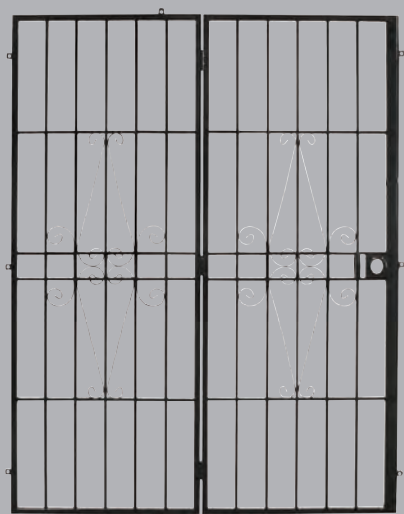

Features

- Standard sizes
5'0" x 6'8" (61-1/2" x 80" Net overall frame)
6'0" x 6'8" (73-1/2" x 80" Net overall frame)
8'0" x 6'8" (97-1/2" x 80" Net overall frame)
- Custom sizes available
- 1" sq. x 18 Ga. frame
- 1/2" sq. x 18 Ga. vertical steel pickets
- 1/2" sq. x 18 Ga. horizontal steel pickets
- 1/8" Thick x 1/2" wide steel scroll designs
- Single hole lock-box w/ 2-1/8" bore & 2-3/8" backset
- Continuous 1/8" x 3/4" lock side "tamper guard"
- Tamper proof hinges
- 16 Ga. expanded metal (1/2") on active door (standard)
- Optional 24 Ga. perforated steel mesh for extra security is available as an upgrade for an additional charge
- Non-handed
- Hinged at center
- 1" Stand-off tab standard

Stocked Finishes

- Black powder coat

***Cannot make in Deco, San Marino, or any other water jet cut patterns on this system**

Features

- Standard sizes
5'0" x 6'8" (61-1/2" x 82-1/2" Net overall frame)
6'0" x 6'8" (73-1/2" x 82-1/2" Net overall frame)
8'0" x 6'8" (97-1/2" x 82-1/2" Net overall frame)
- Custom sizes available
- 1" x 3" x 16 Ga. door jambs
- 1" sq. x 16 Ga. panel frames
- 5/8" sq. x 18 Ga. vertical steel pickets
- 3/8" sq. x 18 Ga. horizontal steel pickets
- 1/8" Thick x 1/2" wide steel scroll designs
- 2" x 2" x 1/8" Bottom sliding angle track
- 2 Point anti-lift system
- Overhead track w/plastic end caps
- Single cylinder hook lock w/lock guard
- Inside & outside handle pulls
- Surface mounted - 1" tabs
- 16 Ga. expanded metal (1/2") on active door (standard)
- Optional 24 Ga. perforated steel mesh for extra security is available as an upgrade for an additional charge

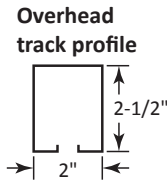

- **Specify left or right active door**

Stocked Finishes

- Built to order
- Knock down (K.D.) kit available
- *Cannot make in Southwest, Sunburst, or any water jet cut patterns on this system
- *Inset mounting tab not available



Features

- Custom built to order
- **1-1/2" sq. x 14 Ga. one piece frame**
- 1" sq. x 16 Ga. steel door frame
- 5/8" sq. x 18 Ga. vertical steel pickets
- 3/8" sq. x 18 Ga. horizontal steel pickets
- 1/8" Thick x 1/2" wide steel scroll design
- Single hole lock-box w/ 2-1/8" bore & 2-3/8" backset
- **Lock ring guard**
- Continuous 1/8" x 1" "tamper guard" on strike, top, & frame
- Tamper proof hinges
- 16 Ga. expanded metal (1/2") on active door (as shown) is standard
- Optional 24 Ga. perforated steel mesh for extra security is available as an upgrade for an additional charge

- **Specify left or right side active door**

- 1-1/2" Stand-off tabs standard
- Hinged at center

Stocked Finishes

- Built to order

Heavy Duty



STEEL PATIO DOORS & ENCLOSURES

Custom options (add-ons)

Product Line Z9999 for all options on this page

Option	Option Code	Description
Mounting Variations (Refer to Page 47)	OP-SurfaceMt	Surface mount (standard)
	OP-PDStndOffTab	Surface mount w/stand-off tabs (specify tab size)
	OP-PDSOTwStrap	Surface mount w/stand-off tabs & protective strap on lock side (specify tab size)
Lock-Box	OP-INSTL8560	Single hole lock-box
	OP-INSTL8559	Double hole lock-box
	OP-RingGuard	Ring guard - welded
	OP-HandlePull	Handle pull
	OP-SpecLBLoc	Special lock-box location
Door Coverings	OP-CONTPERFDD	Contrasting mesh option
	OP-24GaPerf2SD	24 Ga. perforated steel mesh w/ 3/32" dia holes (both sides)
	OP-16GaExpnd2SD	16 Ga. 1/2" expanded metal screen (both sides)
	OP-13GaExpnd2SD	13 Ga. 1/2" expanded metal screen (both sides)
	OP-24GaSolid2SD	24 Ga. solid sheet metal (both sides)
Door designs	OP-PDCarolina	Carolina style
	OP-PDDakota	Dakota style
	OP-PDGranada	Granada style
	OP-PDParadise	Paradise style (select insert)
	OP-PDImpression	Impressions style (select insert)
	OP-PDImperial	Imperial style
	OP-PDWoodguard	Woodguard style
	OP-PDClarion	Clarion style
	OP-PDSunburst	Sunburst style
	OP-PDLongevity	Longevity style (select insert)
	OP-PD Sonoma	Sonoma style
	OP-PDEnglishIvy	English Ivy style
	OP-PDItalianLeaf	Italian Leaf style
OP-PDFranciscan	Franciscan style	
Centurion Enclosure	OP-INSTL8560	Single hole lock-box
	OP-PDCUTOUT	Cut-out (buttresses)
	OP-PDSPCLDOOR	Special size door to 45" x 85-1/2"
Sentinel	OP-FULLFRMSENT	Full frame sentinel (specify handing)
Steelmaster	OP-BOTHACTIVE	Both doors operable
Primer	OP-Primerpaint	Primer undercoat + paint for extra rust protection

STEEL PATIO DOORS & ENCLOSURES

3901 Centurion Enclosure with Door Product Line: G3015

Features

- 1-1/4" sq. x 16 Ga. one piece frame
- 1 ea. 3'0" x 6'8" standard door
- 1" sq. x 16 Ga. steel door frame
- 5/8" sq. x 18 Ga. vertical steel pickets
- 3/8" sq. x 18 Ga. horizontal steel pickets
- 1/8" Thick x 1/2" wide steel scroll designs
- Double hole lock-box w/ 2-1/8" bore & 2-3/8" backset
- Continuous 1/8" x 1" "tamper guard" on lock side & top
- Tamper proof hinges
- Optional 24 Ga. perforated steel mesh for extra security is available as an upgrade for an additional charge
- **Specify handing (refer to page 48)**

Stocked Finishes

- Built to order

Note: Perforated or expanded metal is optional.
See page 41 for custom options.

***Cannot make in Deco, San Marino, or any other water jet cut patterns on this system**

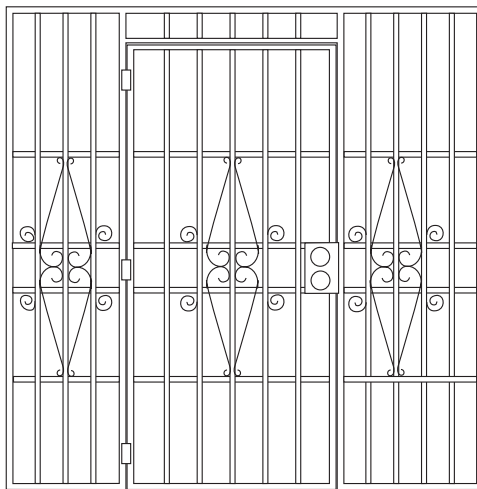

Up to: 7'0" x 8'0" 84" x 96"	Up to: 9'0" x 8'6" 108" x 100"	Up to: 11'0" x 8'6" 132" x 100"	Up to: 13'0" x 8'6" 156" x 100"	Up to: 15'0" x 9'0" 180" x 108"
------------------------------------	--------------------------------------	---------------------------------------	---------------------------------------	---------------------------------------

All Centurion Enclosures are Built to Order
Call for quote on any size or options not shown

3902 Knightguard Hinged Patio Door Product Line: G3015

Features

- 1" sq. x 18 Ga. frame
- 1/2" sq. x 18 Ga. vertical steel pickets
- 1/2" sq. x 18 Ga. horizontal steel pickets
- 1/8" Thick x 1/2" wide steel scroll designs
- Single hole lock-box w/ 2-1/8" bore & 2-3/8" backset
- Continuous 1/8" x 3/4" lock side "tamper guard"
- Tamper proof hinges
- 16 Ga. expanded metal (1/2") on active door (standard)
- Non-handed
- Hinged at center
- 1" Stand-off tabs
- Optional 24 Ga. perforated steel mesh for extra security is available as an upgrade for an additional charge

Stocked Finishes

- Black powder coat

See page 41 for custom options.

***4 Sided frame not available**

***Cannot make in Deco, San Marino, or any other water jet cut patterns on this system**

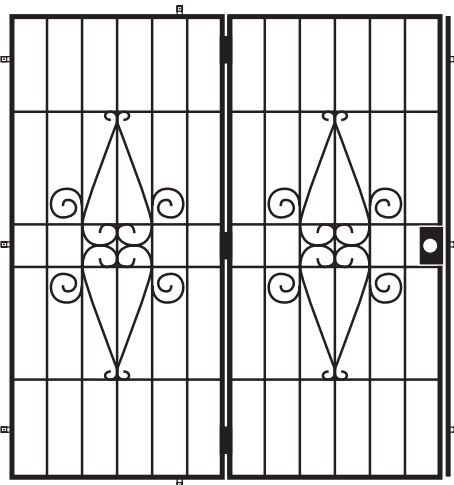

Up to: 5'0" x 6'8" 61-1/2" x 80"	Up to: 6'0" x 6'8" 73-1/2" x 80"	Up to: 8'0" x 6'8" 97-1/2" x 80"	Up to: 8'0" x 8'0" 97-1/2" x 96"	Up to: 10'0" x 8'0" 121-1/2" x 96"
--	--	--	--	--

Call for quote on any size or options not shown

STEEL PATIO DOORS & ENCLOSURES

3903 Sentinel Sliding Patio Door Product Line: G3015

Features

- 1" x 3" x 16 Ga. door jambs
- 1" sq. x 16 Ga. panel frames
- 5/8" sq. x 18 Ga. vertical steel pickets
- 3/8" sq. x 18 Ga. horizontal steel pickets
- 1/8" Thick x 1/2" wide steel scroll designs
- 2" x 2" x 1/8" Bottom sliding angle track
- Overhead track w/plastic end caps
- Single cylinder hook lock w/lock guard
- Inside & outside handle pulls
- Surface mounted - 1" tabs
- 16 Ga. expanded metal (1/2") on active door (standard)
- Optional 24 Ga. perforated steel mesh for extra security is available as an upgrade for an additional charge
- **Specify left or right active door**
- Knock down (K.D.) kit available

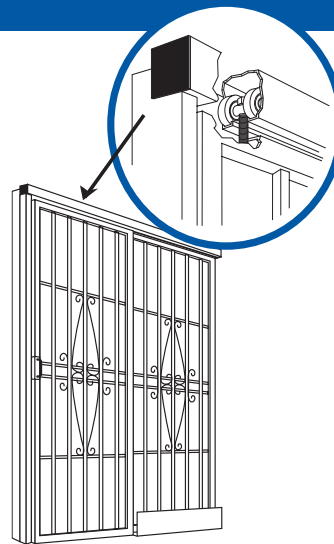

Stocked Finishes

- Built to order

See page 41 for custom options.

***Cannot make in Southwest, Sunburst, or any water jet cut patterns on this system**

Up to:	Up to:	Up to:	Up to:	Up to:
5'0" x 6'8"	6'0" x 6'8"	8'0" x 6'8"	8'0" x 8'0"	10'0" x 8'0"
61-1/2" x 82-1/2"	73-1/2" x 82-1/2"	97-1/2" x 82-1/2"	97-1/2" x 98-1/2"	121-1/2" x 98-1/2"

Call for quote on any size or options not shown

3904 Steelmaster (Full Frame) Product Line: G3015

Features

- 1-1/2" sq. x 14 Ga. one piece frame
- 1" sq. x 16 Ga. steel door frame
- 5/8" sq. x 18 Ga. vertical steel pickets
- 3/8" sq. x 18 Ga. horizontal steel pickets
- 1/8" Thick x 1/2" wide steel scroll design
- Single hole lock-box w/ 2-1/8" bore & 2-3/8" backset
- Lock ring guard
- Continuous 1/8" x 1" "tamper guard" on strike, top, & frame
- Tamper proof hinges
- 16 Ga. expanded metal (1/2") on active door (standard)
- Optional 24 Ga. perforated steel mesh for extra security is available as an upgrade for an additional charge
- 4 Sided frame available
- **Specify left or right side active door**
- 1-1/2" Stand-off tabs standard
- Hinged at center

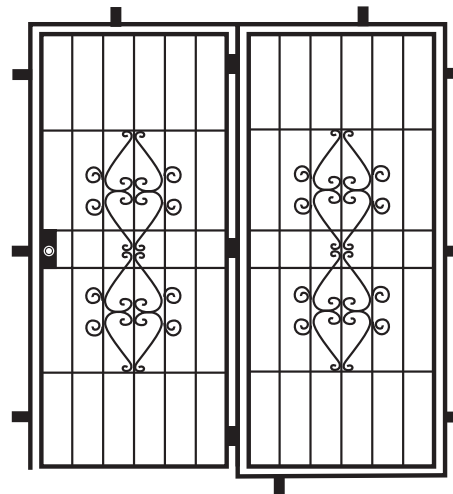

Stocked Finishes

- Built to order

See page 41 for custom options.

Up to:	Up to:	Up to:	Up to:	Up to:
5'0" x 6'8"	6'0" x 6'8"	8'0" x 6'8"	8'0" x 8'0"	10'0" x 8'0"
61-1/2" x 82"	73-1/2" x 82"	97-1/2" x 82"	97-1/2" x 98"	121-1/2" x 98"

Call for quote on any size or options not shown

WINDOW GUARDS

*When installing window guards ALWAYS conform to local building codes.
Precision will not assume liability pertaining to window guard usage/installation.



Note: always measure width x height in ft.- in.

Series No.	Description
450	1/2" sq. Tubular pickets (4" extension) 5/8" sq. Horizontal bars Apache spear point top & bottom All mounting hardware sold separately Black powder coat in stock (except cross hatch)

Product Line:
G3810

Available stocked in black (BK) as shaded in blue below.
All other colors: Almond (AL), bronze (BZ), or white (WH) are only available as special order.

To order in a color other than black, replace the BK in the sample part numbers listed in the table below with the abbreviation of the desired color.

		Width								
		1'6"	2'0"	2'6"	3'0"	3'6"	4'0"	4'6"	5'0"	6'0"
Height	1'6"	450BK1616	450BK2016	450BK2616	450BK3016	450BK3616	450BK4016	450BK4616	450BK5016	450BK6016
	2'0"	450BK1620	450BK2020	450BK2620	450BK3020	450BK3620	450BK4020	450BK4620	450BK5020	450BK6020
	2'6"	450BK1626	450BK2026	450BK2626	450BK3026	450BK3626	450BK4026	450BK4626	450BK5026	450BK6026
	3'0"	450BK1630	450BK2030	450BK2630	450BK3030	450BK3630	450BK4030	450BK4630	450BK5030	450BK6030
	3'6"	450BK1636	450BK2036	450BK2636	450BK3036	450BK3636	450BK4036	450BK4636	450BK5036	450BK6036
	4'0"	450BK1640	450BK2040	450BK2640	450BK3040	450BK3640	450BK4040	450BK4640	450BK5040	450BK6040
	4'6"	450BK1646	450BK2046	450BK2646	450BK3046	450BK3646	450BK4046	450BK4646	450BK5046	450BK6046
	5'0"	450BK1650	450BK2050	450BK2650	450BK3050	450BK3650	450BK4050	450BK4650	450BK5050	450BK6050
6'0"	450BK1660	450BK2060	450BK2660	450BK3060	450BK3660	450BK4060	450BK4660	450BK5060	450BK6060	

For Series 450:

4'6" wide and larger window guards have additional top and bottom locations for center brackets and if used will require **2 additional brackets (part #8103-PK).**

4'6" high and larger window guards have additional horizontal cross bar and if used will require **2 additional brackets (part #8103-PK).**

Window guards beyond 5'0" wide have 2 horizontal scroll patterns. Window guards less than 2'0" in any dimension have modified scroll work.

Series No.	Description
460	5/8" sq. Tubular pickets (4" extension) 5/8" sq. Horizontal bars Apache spear point top & bottom All mounting hardware sold separately Special order for all sizes and colors

Product Line:
G3811



Note: always measure width x height in ft.- in.

Determine the correct part number to order using the following sample number: **460BK3036C**

460 = window guard series; **BK** = color (black); **30** = width in feet & inches (3'0"); **36** = height in feet & inches (3'6")

Available colors: Almond (AL), black (BK), bronze (BZ), or white (WH)

Standard widths: 1'6", 2'0", 2'6", 3'0", 3'6", 4'0", 4'6", 5'0", 6'0" & 8'0" | **Standard heights:** 1'6", 2'0", 2'6", 3'0", 3'6", 4'0", 4'6", 5'0" & 6'0"

For Series 460:

4'6" wide and larger window guards have additional top and bottom locations for center brackets and if used will require **2 additional brackets (part #8103-PK).**

4'6" high and larger window guards have additional horizontal cross bar and if used will require **2 additional brackets (part #8103-PK).**

Window guards beyond 5'0" wide have 2 horizontal scroll patterns. Window guards less than 2'0" in any dimension have modified scroll work.

Series No.	Description
455	1/2" sq. Solid steel pickets 5/8" sq. Horizontal bars Square cut ends top & bottom All mounting hardware sold separately Special order for all sizes and colors

Product Line:
G3812



Note: always measure width x height in ft.- in.

Determine the correct part number to order using the following sample number: **455BK3036C**

455 = window guard series; **BK** = color (black); **30** = width in feet & inches (3'0"); **36** = height in feet & inches (3'6")

Available colors: Almond (AL), black (BK), bronze (BZ), or white (WH)

Standard widths: 1'6", 2'0", 2'6", 3'0", 3'6", 4'0", 4'6", 5'0", 6'0" & 8'0" | **Standard heights:** 1'6", 2'0", 2'6", 3'0", 3'6", 4'0", 4'6", 5'0" & 6'0"

For Series 455:

4'6" wide and larger window guards have additional top and bottom locations for center brackets and if used will require **2 additional brackets (part #8103-PK).**

4'6" high and larger window guards have additional horizontal cross bar and if used will require **2 additional brackets (part #8103-PK).**

Window guards beyond 5'0" wide have 2 horizontal scroll patterns. Window guards less than 2'0" in any dimension have modified scroll work.

CUSTOM WINDOW GUARD APPLICATIONS

(Product Line: Z9999)

*When installing window guards ALWAYS conform to local building codes.
Precision will not assume liability pertaining to window guard usage/installation.

Add to the price of a standard (or custom size) window guard. Mounting brackets shown for clarity and are **not** included.

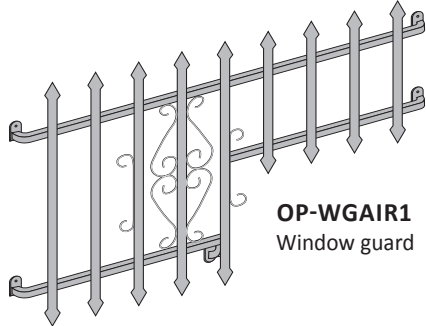

OP-WGAIR1
Window guard

AIR CONDITIONER CUT-OUT

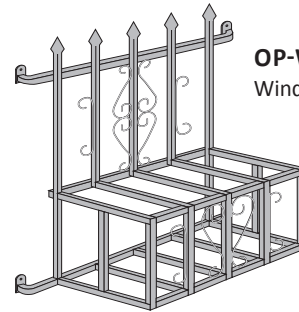

OP-WGAIR2
Window guard

AIR CONDITIONER CAGE

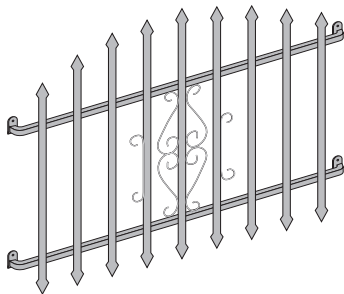

OP-WGPCKTS1
Window guard

ARCHED PICKETS

OP-WGPROV1
Provisions for
top & bottom
brackets



OP-WGWELD1
Weld mesh to
back/front

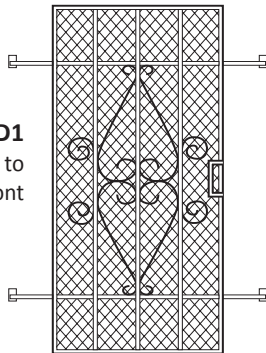

SECURITY MESH (Perforated or expanded)

OP-WGHINGE1

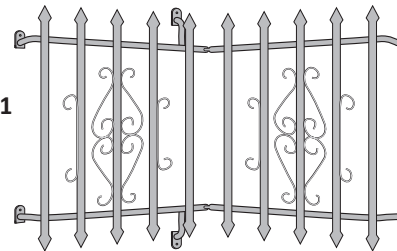

HINGED WINDOW GUARD

WINDOW GUARD ACCESSORIES

Part No.	Product Line	Description
----------	--------------	-------------

Window guard brackets		
<i>All brackets stocked in white and black. Adobe, almond and bronze are made to order</i>		
8100	G8100	3" Standard offset window guard bracket kit Pack consists of: 2 left hand, 2 right hand brackets and 4 each 5/16" x 3" one way lag screws.
8103	G8100	3" Standard center window guard bracket kit Pack consists of: 2 center brackets and 2 each 5/16" x 3" one way lag screws.
8106	G8100	Straight window guard bracket kit Pack consists of: 4 straight brackets and 4 each 5/16" x 3" one way lag screws.
8109	G8100	Flush window guard bracket kit Pack consists of: 2 left hand, 2 right hand flush brackets and 4 each 5/16" x 3" one way lag screws.
8111	G8100	Flush center - black (4 per) w/screws Pack consists of: 2 flush center guard brackets and 4 each 5/16" x 3" one way lag screws.
8113	G8100	1" Offset window guard bracket kit Pack consists of: 2 left hand and 2 right hand brackets and 4 each 5/16" x 3" one way lag screws.
8115	G8100	6" Offset window guard bracket kit Pack consists of: 2 left hand and 2 right hand brackets and 4 each 5/16" x 3" one way lag screws.
8116	G8100	Hinged center bracket Poly bag of 1 each; available in black.
8118	G8100	"T" bracket window guard kit Pack consists of: 2 "T" brackets and 2 each 5/16" x 3" one way lag screws.
8119	G8100	3" x 12" Offset window guard bracket kit

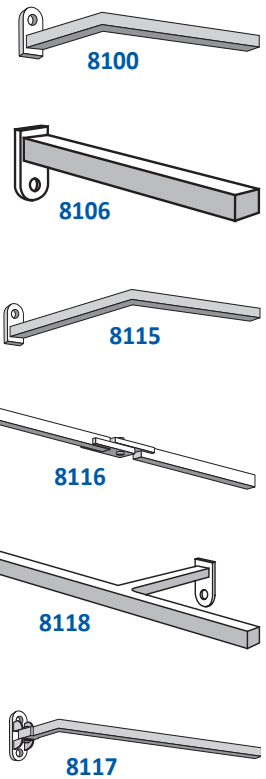

Hardware		
8117	G8100	Fire release hinge bracket kit Pack consists of: 1 fire release bracket and 1 each 5/16" x 3" one way lag screws; available in almond, black and white.
8124	G8100	Fire release shielded cable kit Order lag screws separately; available in black and white.

Part No.	Product Line	Pack QTY	Description
----------	--------------	----------	-------------

Tools			
8900	G8100	1	One way driving tool
8901	G8100	1	Adapter, used for 1/2" square drive

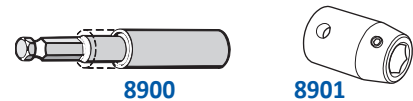

Fasteners			
<i>Available in adobe, almond, black, bronze and white</i>			
8130-2-4PK	G8100	4	5/16" x 2" lag screws
8130-3-4PK	G8100	4	5/16" x 3" lag screws
8130-4-4PK	G8100	4	5/16" x 4" lag screws
8130-2-100PK	G8100	100	5/16" x 2" lag screws
8130-3-100PK	G8100	100	5/16" x 3" lag screws
8130-4-100PK	G8100	100	5/16" x 4" lag screws



*Sample number for fasteners: **8130AD3-4PK** for a pack of 4 adobe colored 3" lag screws

SECURITY MESH GUARD

Part No.	Product Line	Description
DG30	G3813	23-1/4" x 43", Fits 30" door
DG32	G3813	25-1/4" x 43", Fits 32" door
DG36	G3813	29-1/4" x 43", Fits 36" door

Security mesh guard features:

- Strong 16 gauge expanded metal
- 1" angle - steel frame
- Black powder coat standard
- Complete with tabs and four 1" one-way screws

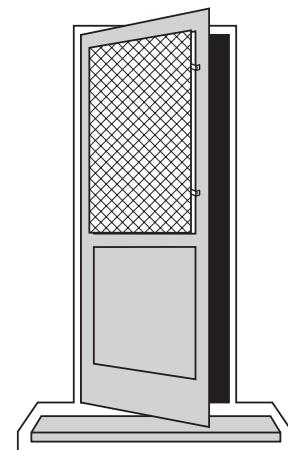

MESH GUARD OPTIONS

Part No.	Product Line	Description
DG11	—	Stand-off tabs - additional
DG100	G3813	1/2" Expanded metal (16 ga.)
DG200	G3813	Perforated metal (24 ga.)
DG300	G3813	Solid metal (24 ga.)

SECURITY DOOR MOUNTING VARIATIONS

SURFACE MOUNT

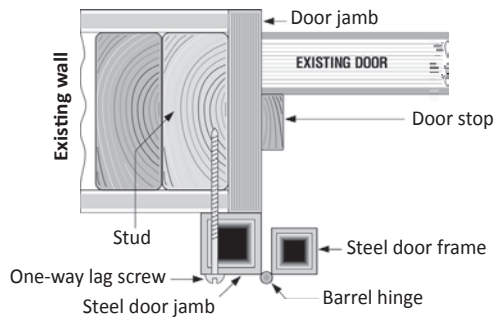

Surface mount standard

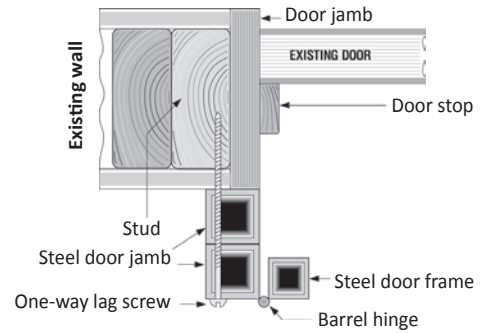

Surface mount w/tube backing

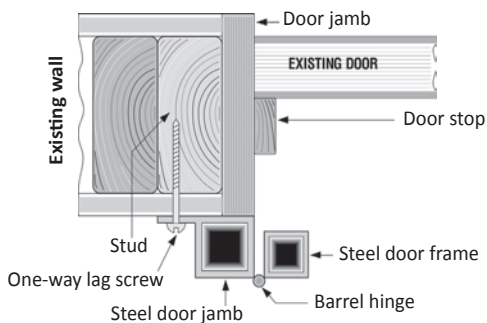

Surface mount w/tabs

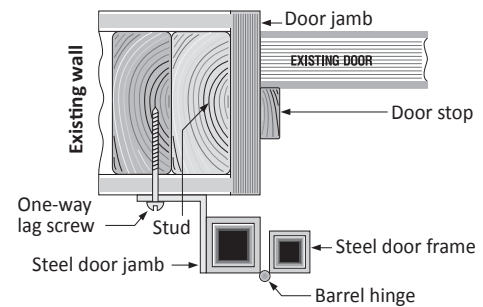

Surface mount w/stand-off tabs

INSET MOUNT

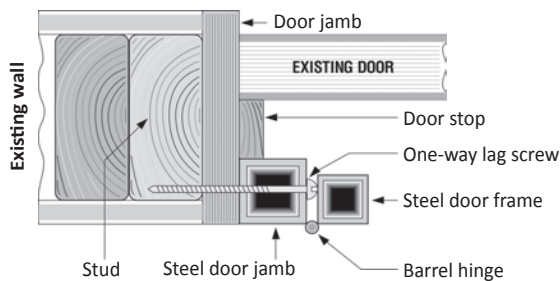

Inset mount

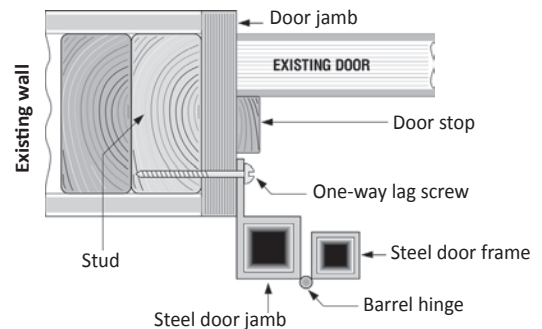

Inset mount w/tab

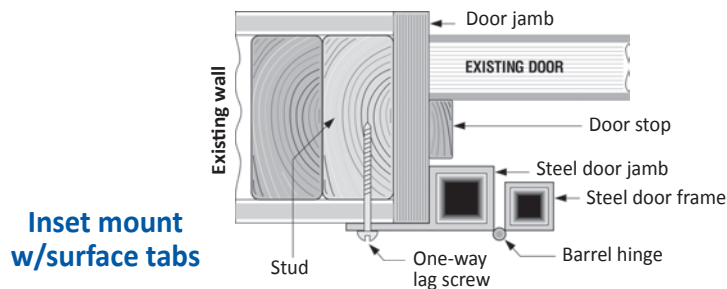

Inset mount w/surface tabs

Step 1: Determine Door Width

Measure the opening **"Width"** between the left and right **door jambs** as seen in **(Diagram A)**.

Record Opening **"Width"** Here: _____ "

(See page 4 of this worksheet for mounting options)

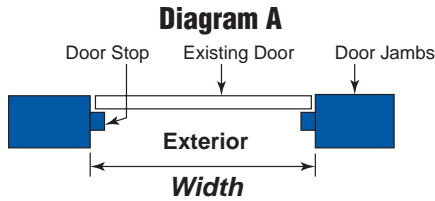

FOR SURFACE MOUNT

Then add 3" to arrive at the finished door width: _____ "

(Add 3-1/2" for *Steel Master, English Ivy, Italian Leaf, & Sonoma Doors*)

FOR INSET MOUNT

Then subtract 1/4" to arrive at the finished door width: _____ "

Step 2: Determine Door Height

Measure the opening **"Height"** from the bottom of door header to the top of the threshold as seen in **(Diagram B)**.

Record Opening **"Height"** Here: _____ "

For a three (3) sided frame

FOR SURFACE MOUNT

Add 1-3/4" to arrive at the finished door height: _____ "
(Add 2" for *Steel Master, English Ivy, Italian Leaf, & Sonoma Doors*)

FOR INSET MOUNT

Subtract 1/4" to arrive at the finished door height: _____ "

For a four (4) sided frame

FOR SURFACE MOUNT

Add 3" to arrive at the finished door height: _____ "
(Add 3-1/2" for *Steel Master, English Ivy, Italian Leaf, & Sonoma Doors*)

FOR INSET MOUNT

Subtract 1/4" to arrive at the finished door height: _____ "

Diagram B

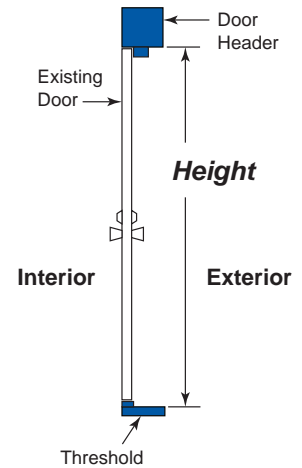

Step 3: Determine Hinge Side

Specify placement as either **"Left (or) Right Hand"** hinged as viewed from the **outside of the door looking in** as seen in **(Diagram C)**.

Left Hand Hinge **OR** Right Hand Hinge

Diagram C

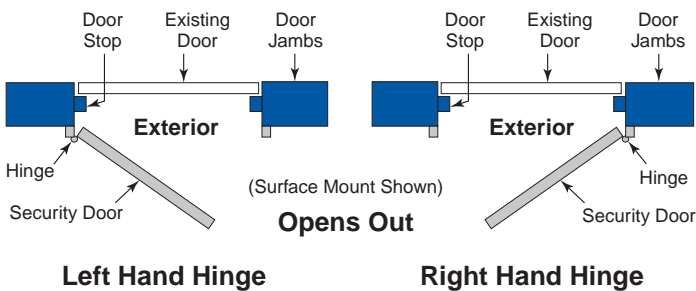

Step 4: Determine Lockbox Height

Measure from bottom of the door to center of the **"Lockbox"** as seen in **(Diagram D)**.

Record **"Lockbox"** Height Here: _____

Note: "Lockbox" will be "centered" if Lockbox height is "not" specified.

Diagram D

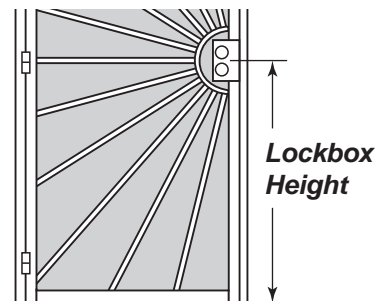

Step 5: Complete the following three (3) page order form and send it to our Precision customer service team.

Customer: _____

Door Model: _____

P.O.: _____ Date: _____

Door Size: Width: _____ Height: _____

Steel Security Doors:

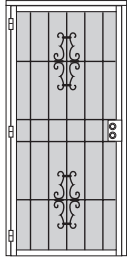

Granada

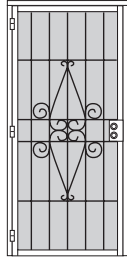

Barcelona

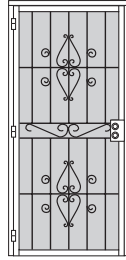

Madrid

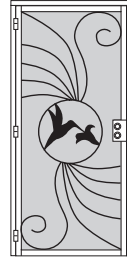

Paradise
(With Insert)

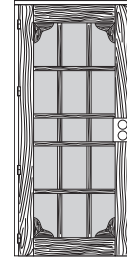

Woodguard

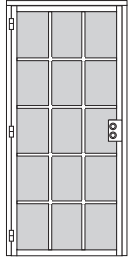

Carolina

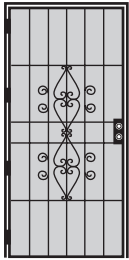

Steel Master

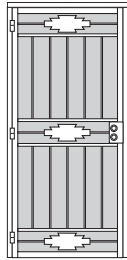

Dakota

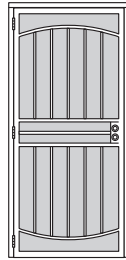

Franciscan

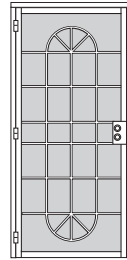

Clarion



Impressions
(With Insert)



Italian Leaf



English Ivy



Sonoma

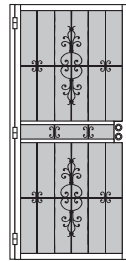

Imperial

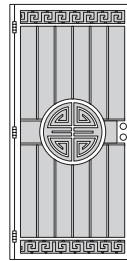

Longevity
(With Insert)

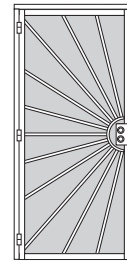

Sunburst

Water Jet Cut Door Designs:



Vineyard
(With Insert)



Full Vine

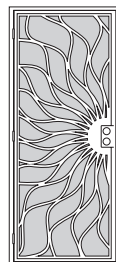

Southwest

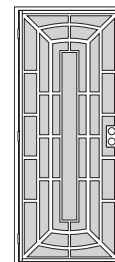

San Marino

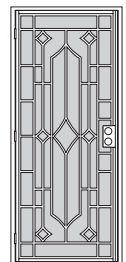

Deco

Color:

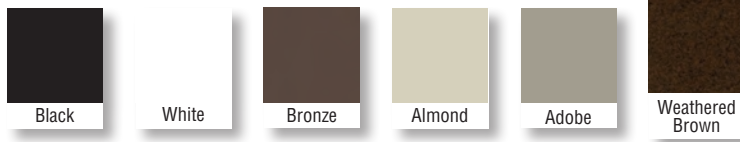

Door	<input type="checkbox"/>	<input type="checkbox"/>	<input type="checkbox"/>	<input type="checkbox"/>	<input type="checkbox"/>	<input type="checkbox"/>
Mesh	<input type="checkbox"/>	<input type="checkbox"/>	<input type="checkbox"/>	<input type="checkbox"/>	<input type="checkbox"/>	<input type="checkbox"/>

Primer:

Double Coat High Zinc Primer

Single Color Door
(Mesh to Match Door/Frame – Standard)

Contrasting Mesh (Two Tone)

Door Cover:

- 24 Ga. Perf (Standard)
- 1/2" Expanded (16 Ga.)
- Hex Perf with screen (22 Ga.)
- Hex Perf with screen (16 Ga.)
- Cloverleaf Perf with screen (22 Ga.)
- Grecian Perf with screen (22 Ga.)
- No Covering



Perforated

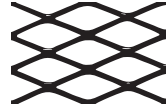

1/2" Expanded



Hex Perf



Cloverleaf Perf

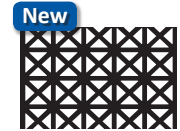

Grecian Perf

Hex Perf, Cloverleaf Perf and Grecian Perf door covers allow for high air flow and improved visibility.

Contrasting mesh is **not** available with **Hex Perf** door covers.

Handing: Single Door (Viewed from the outside looking in)

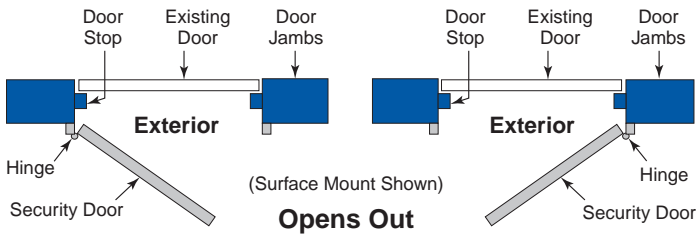

Left Hand Hinge

Right Hand Hinge

Left Hand Hinge

Right Hand Hinge

Active Door: Double Door (Viewed from the outside looking in)

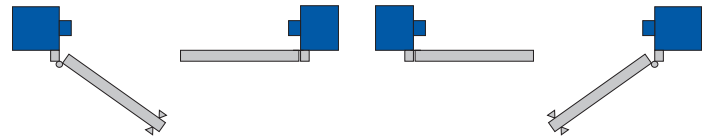

Left Door Active

Right Door Active

Left Door Active

Right Door Active

Cane Bolts

Flush Extension Bolts

Lock-Box:

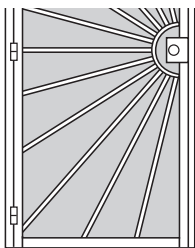

Single Hole

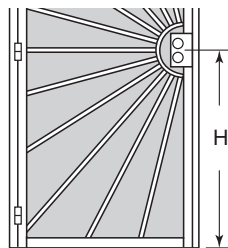

Double Hole

Double Hole (Standard)

Single Hole

Distance from Bottom of Door to Center of Lock-Box: _____
(Lock-Box at Center - Standard)

Frame:

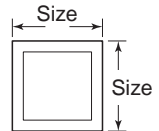

1-1/4" square (3) Piece (Standard)

1-1/4" square **One Piece** Welded Frame (3) Sided

1-1/4" square **One Piece** Welded Frame (4) Sided

1-1/2" square **One Piece** Welded Frame (3) Sided
(Standard on: Steel Master, English Ivy, Italian Leaf, & Sonoma)

1-1/2" square **One Piece** Welded Frame (4) Sided

Mounting:

- Surface (Standard)
- Inset
- Inset with Tabs
- Surface with Tabs
- Inset with Surface Tabs

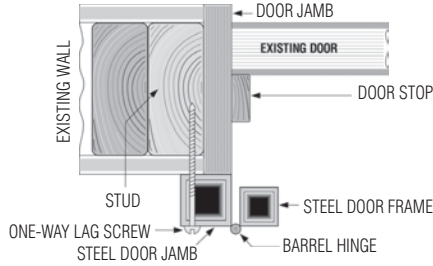

SURFACE MOUNT (STANDARD)

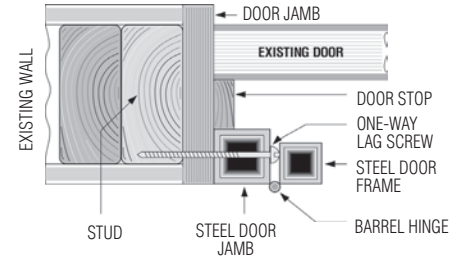

INSET MOUNT

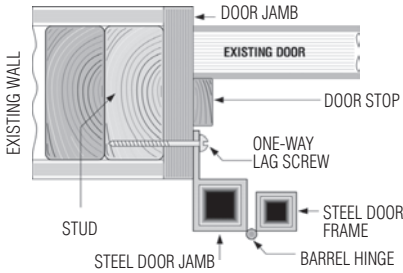

INSET MOUNT W/TAB

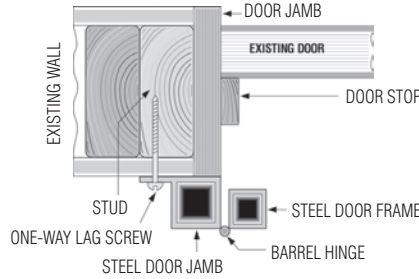

SURFACE MOUNT W/TABS

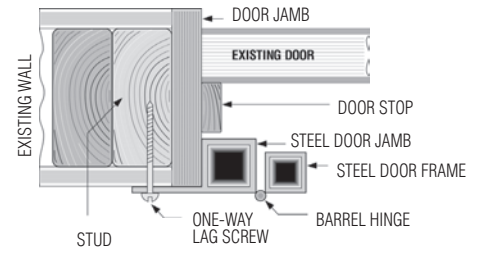

INSET MOUNT W/SURFACE TABS

Removable Center Insert Designs (See page 35): (For Our Impressions, Paradise, Longevity, & Vineyard Doors Only)



Cactus



Coyote



Deer scene



Dolphins



Gecko



Horse



Hummingbird



Longevity



Love birds



Palm tree



Welcome



Whale tail

***Ask about our custom design services**

PRECISION SCREEN & SECURITY PRODUCTS

PRO STEEL SECURITY DOOR WORKSHEET

Door Model: _____			Customer: _____		
Size: _____ Width x _____ Height			P.O.: _____		
Net Frame (Overall Width x Overall Height)			Date: _____		
Color:	Door	Mesh	Frame:	1-1/4" sq. (3) Piece (Std.)	
Black				1-1/4" sq. One Piece (3) Sided	
White				1-1/4" sq. One Piece (4) Sided	
Bronze				1-1/2" sq. (3) Piece	
Almond				1-1/2" sq. One Piece (3) Sided	
Adobe				1-1/2" sq. One Piece (4) Sided	
Weathered Brown			Mounting:	Surface Mount (Std.)	
Primer:	Double Coat			Inset Mount	
	High Zinc Primer			Inset Mount w/Tabs	
Door Cover:	24 Ga. Perf (Standard)			Inset Mount w/Offset Tabs	
	1/2" Expanded (16 Ga.)			Surface Mount w/Tabs	
	No Covering			Inset Mount w/Surface Tabs	
	Stainless Steel Mesh (Black Only)			Surface Mount w/Stand-off Tabs	
	Hex Perf w/Screen (22 Ga.)			Tab Length (1", 1-1/2", 2", 3")	
	Hex Perf w/Screen (16 Ga.)			Surface Mount Tube Backing	
	1/2" Expanded (13 Ga.)			Inset Mount w/Full Strapping	
	Solid Sheet (24 Ga.)			Strapping Width (1-1/2", 2", 3" 4")	
Handing:	Right Hand Hinge		Center Insert Designs:	Cactus	
Single Door	Left Hand Hinge			Coyote	
(Outside Looking In)	Opens Out		(Impressions)	Deer scene	
	Opens In		(Longevity)	Dolphins	
Active Door:	Right Door Active		(Paradise)	Gecko	
Double Door	Left Door Active		(Vineyard)	Horse	
(Outside Looking In)	Flush Extension Bolts			Hummingbird	
	Cane Bolts			Longevity	
	Flush Top - Cane Bottom			Love birds	
Lock-Box:	Double Hole (Standard)			Palm tree	
	Single Hole			Welcome	
	Ring Guard			Whale tail	
	Distance from Bottom of Door to Center of Lock-Box (Lock-Box at Center - Standard)		Plasma Cut Door Designs:	Vineyard w/Insert	
Special Instructions:				Full Vine	
				Southwest	
				San Marino	
				Deco	
			Mail Slot:	Mail Slot w/No Cover	
				Mail Slot w/Cover	
			Mail Slot Location:		